









rotary operating mechanism, actuating lever Red / yellow, for center-hole Front mounting, for 25 A and 32 A, Accessory for main and emergency switching-off switch 3LD2

| Model | |
|--|---|
| product brand name | SENTRON |
| product designation | Rotary operators |
| design of the product | accessories for 3LD2 main and EMERGENCY-STOP switches |
| degree of protection NEMA rating | 1, 3R, 4X, 12 |
| suitability for use switch disconnecter | Yes |
| suitability for use circuit breaker | No |
| suitability for use EMERGENCY OFF switch | Yes |
| color | red / yellow |
| • of the actuating element | red / yellow |
| product feature can be locked in ON position | No |
| • Product component with axis | No |
| • product component restart inhibit function block | No |
| • product component padlock locking mechanism | No |
| • product component key lock | No |
| product feature can be locked into OFF position | Yes |
| number of bracket locks maximum | 3 |
| hasp thickness of the bracket locks | 4 ... 8 mm |
| Net Weight | 78 g |

Approvals Certificates

| General Product Approval | other | Environment |
|---|--|---|
|  |  EG-Konf. |  |
| |  |  |
| | |  |

Environment

[Environmental Confirmations](#)

Further information

Information on the packaging
<https://support.industry.siemens.com/cs/ww/en/view/109813875>
 Information for data generation and storage
<https://support.industry.siemens.com/cs/ww/en/view/109995012>
 Information- and Downloadcenter (Catalogs, Brochures,...)

<https://www.siemens.com/lowvoltage/catalogs>

Industry Mall (Online ordering system)

<https://mall.industry.siemens.com/mall/en/en/Catalog/product?mlfb=3LD9224-3D>

Service&Support (Manuals, Certificates, Characteristics, FAQs,...)

<https://support.industry.siemens.com/cs/ww/en/ps/3LD9224-3D>

Image database (product images, 2D dimension drawings, 3D models, device circuit diagrams, ...)

https://www.automation.siemens.com/bilddb/cax_en.aspx?mlfb=3LD9224-3D

CAX-Online-Generator

<https://www.siemens.com/cax>

Tender specifications

<https://www.siemens.com/specifications>

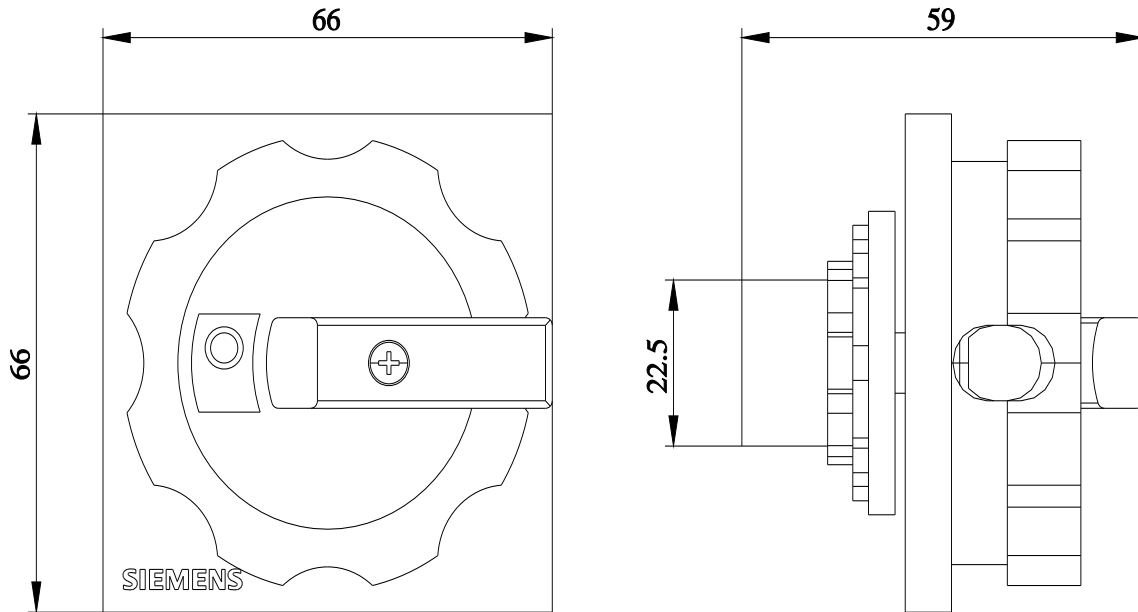

last modified:

10/25/2025 

