



SITOR fuse size 00 160A aR 440V dc/700V VSI 500V dc UL @MBC 4xIn blade contacts

Model		
product brand name	SETRON	
product designation	SITOR fuse link	
design of the product	with blade contacts without slots	
design of an identification indicator	with front indicator	
design of the fuse link	SITOR, LV HRC design	
General technical data		
size of fuse system according to EN 60269-1	NH00	
operating class of the fuse link	aR	
type of voltage of the operating voltage	DC	
Supply voltage		
supply voltage		
• at DC	440 V	
Breaking Capacity		
switching capacity current		
• at DC according to IEC 60947-2 rated value	100 kA	
• according to IEC 60947-2 rated value	100 kA	
Dissipation		
power loss [W]	38 W	
power loss [W]		
• for rated value of the current at AC in hot operating state per pole	38 W	
• maximum	38 W	
Product details		
product description	with blade contacts, silver-plated	
accessories included	no	
Mechanical Design		
mounting position	Any, preferably vertical	
Net Weight	195 g	
Environmental conditions		
ambient temperature during operation		
• minimum	-20 °C	
• maximum	50 °C	
environmental category	-20 to +50 at 95% relative humidity	
Approvals Certificates		
General Product Approval	other	Environment



Confirmation



Environment

[Environmental Confirmations](#)

Further information

Information on the packaging

<https://support.industry.siemens.com/cs/ww/en/view/109813875>

Information for data generation and storage

<https://support.industry.siemens.com/cs/ww/en/view/109995012>

Information- and Downloadcenter (Catalogs, Brochures,...)

<https://www.siemens.com/lowvoltage/catalogs>

Industry Mall (Online ordering system)

<https://mall.industry.siemens.com/mall/en/en/Catalog/product?mlfb=3NB1725-0KK10>

Service&Support (Manuals, Certificates, Characteristics, FAQs,...)

<https://support.industry.siemens.com/cs/ww/en/ps/3NB1725-0KK10>

Image database (product images, 2D dimension drawings, 3D models, device circuit diagrams, ...)

https://www.automation.siemens.com/bilddb/cax_en.aspx?mlfb=3NB1725-0KK10

CAx-Online-Generator

<https://www.siemens.com/cax>

Tender specifications

<https://www.siemens.com/specifications>

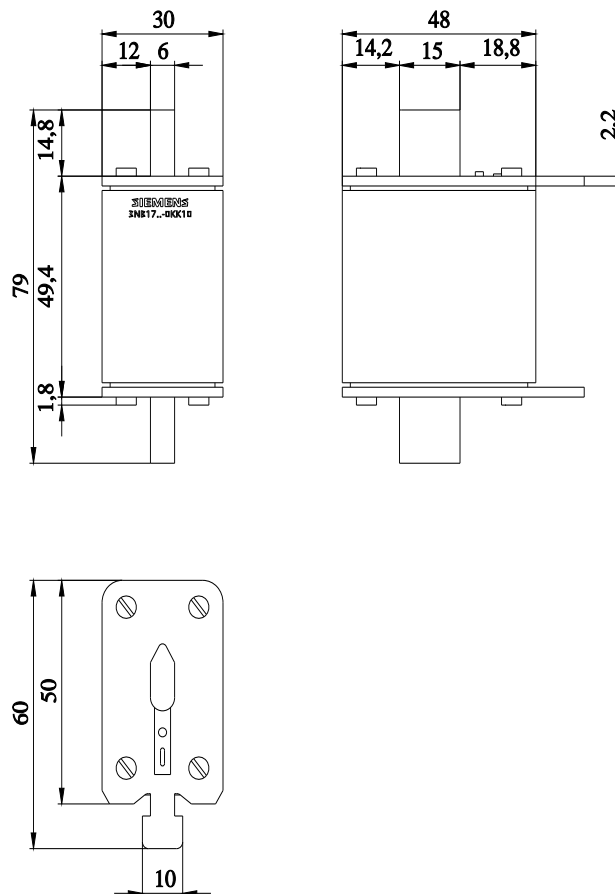

last modified:

4/4/2025

