

SITOR fuse switch 14x 51, Up to 50 A, 690 V AC



Model	
product brand name	SENTRON
product designation	SITOR fuse switch disconnecter
design of the actuating element	swivel knob
General technical data	
number of poles	2
size of fuse link	14x51
utilization category	According to IEC 60947-3; AC 22B/50 A/400 V; AC22B/20 A/690 V
size of the fuse link	14 x 51 mm
operating voltage	
• at AC rated value maximum	690 V
• at DC rated value maximum	700 V
Protection class	
protection class IP on the front	IP20
Main circuit	
operational current rated value	50 A
Suitability	
suitability for use main switch	No
suitability for use switch disconnector	Yes
suitability for use EMERGENCY OFF switch	No
suitability for use safety switch	Yes
Product function	
product function fuse monitoring	No
Short circuit	
conditional short-circuit current (I _q) rated value	100 kA
Connections	
connectable conductor cross-section solid	
• minimum	1.5 mm ²
• maximum	35 mm ²
type of electrical connection for main current circuit	screw-type terminals
Mechanical Design	
height	96 mm
depth	69 mm
fastening method	
• floor mounting	No
• rail mounting	No
Net Weight	210 g
Approvals Certificates	
General Product Approval	



General Product Approval

other

Environment



[Confirmation](#)

[Environmental Confirmations](#)

[Environmental Confirmations](#)

Further information

Information on the packaging

<https://support.industry.siemens.com/cs/ww/en/view/109813875>

Information for data generation and storage

<https://support.industry.siemens.com/cs/ww/en/view/109995012>

Information- and Downloadcenter (Catalogs, Brochures,...)

<https://www.siemens.com/lowvoltage/catalogs>

Industry Mall (Online ordering system)

<https://mall.industry.siemens.com/mall/en/en/Catalog/product?mlfb=3NC1492>

Service&Support (Manuals, Certificates, Characteristics, FAQs,...)

<https://support.industry.siemens.com/cs/ww/en/ps/3NC1492>

Image database (product images, 2D dimension drawings, 3D models, device circuit diagrams, ...)

https://www.automation.siemens.com/bilddb/cax_en.aspx?mlfb=3NC1492

CAX-Online-Generator

<https://www.siemens.com/cax>

Tender specifications

<https://www.siemens.com/specifications>

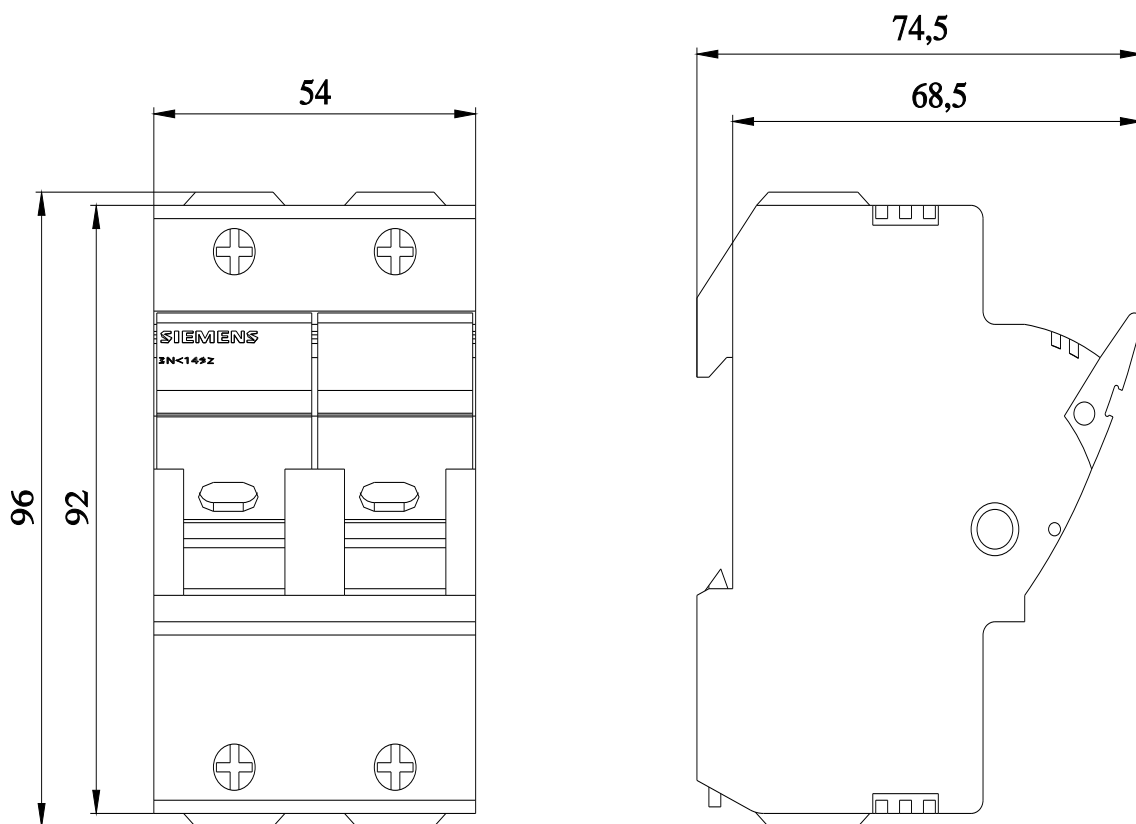



last modified:

11/14/2025 [↗](#)

