

SITOR fuse link, with Bolt-on links, In: 20 A, gR, Un AC: 690 V, Un DC: 440 V, without indicator



Figure similar

Model	
product brand name	SENTRON
product designation	SITOR fuse link
design of the product	with angle connector
design of an identification indicator	Without indicator
design of the switching contact	with M5 bolt-on links. mounting dimension: 75 mm. for screwing onto busbars
design of the fuse link	SITOR, BS design
General technical data	
size of fuse system according to EN 60269-1	Other (BS)
operating class of the fuse link	gR
type of voltage of the operating voltage	AC/DC
Supply voltage	
supply voltage	
• at AC	690 V
• at DC	440 V
Breaking Capacity	
switching capacity current	
• at DC according to IEC 60947-2 rated value	50 kA
• according to IEC 60947-2 rated value	100 kA
Dissipation	
power loss [W]	6.8 W
power loss [W]	
• for rated value of the current at AC in hot operating state per pole	6.8 W
• maximum	6.8 W
Product details	
product description	with bolt-on links, silver-plated
accessories included	no
Mechanical Design	
mounting position	Any, preferably vertical
Net Weight	0.043 kg
Environmental conditions	
ambient temperature during operation	
• minimum	-20 °C
• maximum	50 °C
environmental category	-20 to +50 at 95% relative humidity
Approvals Certificates	
General Product Approval	other



other Environment

[Confirmation](#)

[Environmental Con-  
firmations](#)

[Environmental Con-  
firmations](#)

Further information

Information on the packaging

<https://support.industry.siemens.com/cs/ww/en/view/109813875>

Information for data generation and storage

<https://support.industry.siemens.com/cs/ww/en/view/109995012>

Information- and Downloadcenter (Catalogs, Brochures,...)

<http://www.siemens.com/lowvoltage/catalogs>

Industry Mall (Online ordering system)

<https://mall.industry.siemens.com/mall/en/en/Catalog/product?mlfb=3NC1820-0MK>

Service&Support (Manuals, Certificates, Characteristics, FAQs,...)

<https://support.industry.siemens.com/cs/ww/en/ps/3NC1820-0MK>

Image database (product images, 2D dimension drawings, 3D models, device circuit diagrams, ...)

[http://www.automation.siemens.com/bilddb/cax\\_en.aspx?mlfb=3NC1820-0MK](http://www.automation.siemens.com/bilddb/cax_en.aspx?mlfb=3NC1820-0MK)

CAX-Online-Generator

<http://www.siemens.com/cax>

Tender specifications

<http://www.siemens.com/specifications>

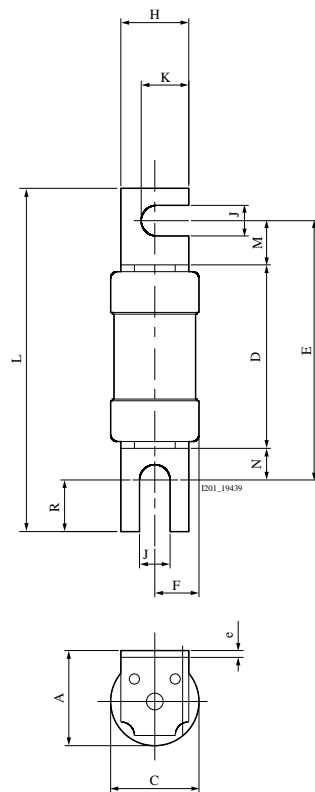

Type	Dimensions												
	Ø C	A	D	E	F	H	K	L	M	N	R	e	
3NC18..-0MK	18	19	52,2	71,5	9	12	9	88	12	7	14	1,4	
3NC26..-0MK	26	29	53,5	75,8	13	19	14	103	13	9,3	19,7	2	

last modified:

4/11/2025

