



Figure similar

SITOR fuse link, with female thread on both sides, In: 315 A, aR, Un AC: 800 V, Un DC: 440 V, front indicator

Model		
product brand name	SETRON	
product designation	SITOR fuse link	
design of the product	With female thread on both sides	
design of an identification indicator	front indicator	
design of the switching contact	with female thread at both ends for SITOR 6QG12 thyristor sets	
design of the fuse link	Fuses for special applications	
General technical data		
size of fuse system according to EN 60269-1	others	
operating class of the fuse link	aR	
varying load factor (WL)	0.85	
type of voltage of the operating voltage	AC/DC	
operating voltage at AC according to UL rated value	800 V	
Supply voltage		
supply voltage		
• at AC	800 V	
• at DC	440 V	
Breaking Capacity		
switching capacity current		
• according to IEC 60947-2 rated value	100 kA	
Dissipation		
power loss [W]	120 W	
power loss [W]		
• for rated value of the current at AC in hot operating state per pole	120 W	
• maximum	120 W	
Product details		
product description	with female thread on both sides, silver-plated	
accessories included	no	
Mechanical Design		
mounting position	Any, preferably vertical	
Net Weight	690 g	
Environmental conditions		
ambient temperature during operation		
• minimum	-20 °C	
• maximum	50 °C	
environmental category	-20 to +50 at 95% relative humidity	
Approvals Certificates		
General Product Approval	Test Certificates	other



Special Test Certificate



Confirmation

other

Environment

[Miscellaneous](#)

[Environmental Confirmations](#)

[Environmental Confirmations](#)

Further information

Information on the packaging

<https://support.industry.siemens.com/cs/ww/en/view/109813875>

Information for data generation and storage

<https://support.industry.siemens.com/cs/ww/en/view/109995012>

Information- and Downloadcenter (Catalogs, Brochures,...)

<http://www.siemens.com/lowvoltage/catalogs>

Industry Mall (Online ordering system)

<https://mall.industry.siemens.com/mall/en/en/Catalog/product?mlfb=3NE4330-6B>

Service&Support (Manuals, Certificates, Characteristics, FAQs,...)

<https://support.industry.siemens.com/cs/ww/en/ps/3NE4330-6B>

Image database (product images, 2D dimension drawings, 3D models, device circuit diagrams, ...)

http://www.automation.siemens.com/bilddb/cax_en.aspx?mlfb=3NE4330-6B

CAX-Online-Generator

<http://www.siemens.com/cax>

Tender specifications

<http://www.siemens.com/specifications>

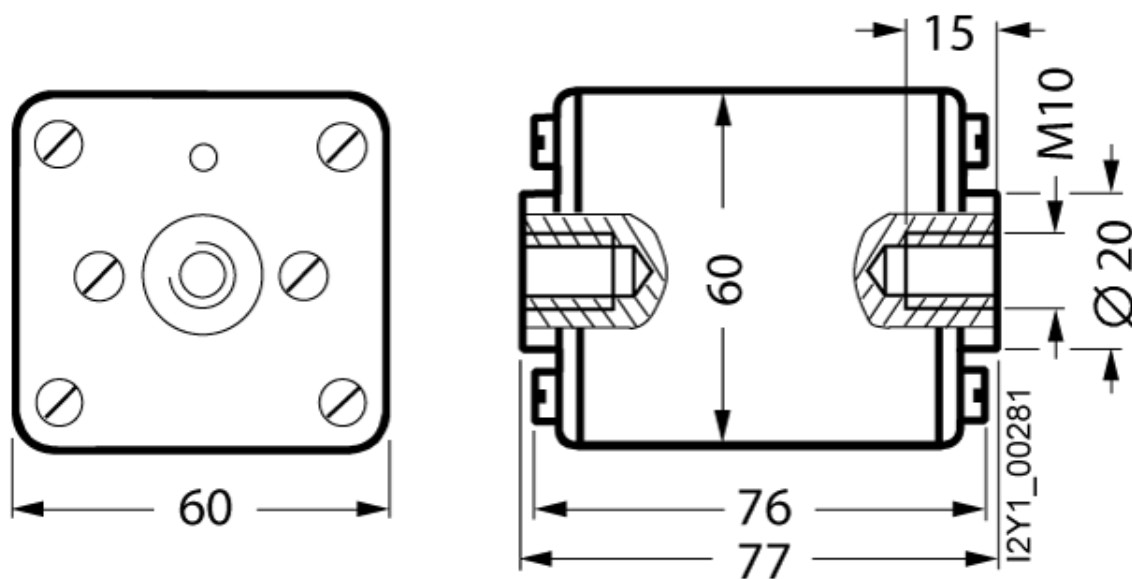

last modified:

4/11/2025

