

reversing contactor assembly, AC-3e/AC-3, 16 A, 7.5 kW / 400 V, 3-pole, 220 V AC, 50 Hz / 240 V, 60 Hz, screw terminal, electrical and mechanical interlock



<b>product brand name</b>	SIRIUS
<b>product designation</b>	Reversing contactor assembly
<b>product type designation</b>	3RA23
<b>manufacturer's article number</b>	
<ul style="list-style-type: none"> <li>• 1 of the supplied contactor</li> <li>• 2 of the supplied contactor</li> <li>• of the supplied RH assembly kit</li> </ul>	<a href="#">3RT2018-1AP62</a> <a href="#">3RT2018-1AP62</a> <a href="#">3RA2913-2AA1</a>
<b>General technical data</b>	
<b>size of contactor</b>	S00
product extension auxiliary switch	Yes
<b>shock resistance at rectangular impulse</b>	
<ul style="list-style-type: none"> <li>• at AC</li> <li>• at DC</li> </ul>	7,3g / 5 ms, 4,7g / 10 ms 7,3g / 5 ms, 4,7g / 10 ms
<b>shock resistance with sine pulse</b>	
<ul style="list-style-type: none"> <li>• at AC</li> <li>• at DC</li> </ul>	11,4g / 5 ms, 7,3g / 10 ms 11,4g / 5 ms, 7,3g / 10 ms
<b>mechanical service life (operating cycles)</b>	
<ul style="list-style-type: none"> <li>• of contactor typical</li> <li>• of the contactor with added auxiliary switch block typical</li> </ul>	10 000 000 10 000 000
<b>reference code according to IEC 81346-2</b>	Q
<b>Substance Prohibitance (Date)</b>	10/01/2009
<b>Weight</b>	0.5 kg
<b>Ambient conditions</b>	
installation altitude at height above sea level maximum	2 000 m
<b>ambient temperature</b>	
<ul style="list-style-type: none"> <li>• during operation</li> <li>• during storage</li> </ul>	-25 ... +60 °C -55 ... +80 °C
<b>Main circuit</b>	
<b>number of poles for main current circuit</b>	3
<b>number of NO contacts for main contacts</b>	3
<b>number of NC contacts for main contacts</b>	0
<b>operating voltage</b>	
<ul style="list-style-type: none"> <li>• at AC-3 rated value maximum</li> <li>• at AC-3e rated value maximum</li> </ul>	690 V 690 V
<b>operational current</b>	
<ul style="list-style-type: none"> <li>• at AC-3 <ul style="list-style-type: none"> <li>— at 400 V rated value</li> <li>— at 500 V rated value</li> <li>— at 690 V rated value</li> </ul> </li> <li>• at AC-3e</li> </ul>	16 A 12.4 A 8.9 A

— at 400 V rated value	16 A
— at 500 V rated value	12.4 A
— at 690 V rated value	8.9 A
<b>operating power</b>	
● at AC-3	
— at 400 V rated value	7.5 kW
— at 500 V rated value	7.5 kW
— at 690 V rated value	7.5 kW
● at AC-3e	
— at 400 V rated value	7.5 kW
— at 690 V rated value	7.5 kW
● at AC-4 at 400 V rated value	5.5 kW
<b>operating frequency</b>	
● at AC-3 maximum	750 1/h
● at AC-3e maximum	750 1/h
<b>Control circuit/ Control</b>	
<b>type of voltage of the control supply voltage</b>	AC
<b>control supply voltage 1 at AC</b>	
● at 50 Hz rated value	220 V
● at 60 Hz rated value	240 V
<b>operating range factor control supply voltage rated value of magnet coil at AC</b>	
● at 50 Hz	0.8 ... 1.1
● at 60 Hz	0.85 ... 1.1
<b>apparent pick-up power of magnet coil at AC</b>	
● at 50 Hz	37 VA
<b>inductive power factor with closing power of the coil</b>	
● at 50 Hz	0.8
<b>apparent holding power of magnet coil at AC</b>	
● at 50 Hz	5.7 VA
<b>inductive power factor with the holding power of the coil</b>	
● at 50 Hz	0.28
<b>Auxiliary circuit</b>	
<b>contact reliability of auxiliary contacts</b>	< 1 error per 100 million operating cycles
<b>UL/CSA ratings</b>	
<b>full-load current (FLA) for 3-phase AC motor</b>	
● at 480 V rated value	14 A
● at 600 V rated value	11 A
yielded mechanical performance [hp] for 3-phase AC motor	
● at 200/208 V rated value	3 hp
● at 220/230 V rated value	5 hp
● at 460/480 V rated value	10 hp
● at 575/600 V rated value	10 hp
<b>contact rating of auxiliary contacts according to UL</b>	A600 / Q600
<b>Short-circuit protection</b>	
<b>design of the fuse link</b>	
● for short-circuit protection of the main circuit	
— with type of coordination 1 required	gG NH 3NA, DIAZED 5SB, NEOZED 5SE: 50 A
— with type of coordination 2 required	gG NH 3NA, DIAZED 5SB, NEOZED 5SE: 25 A
● for short-circuit protection of the auxiliary switch required	fuse gG: 10 A
<b>Installation/ mounting/ dimensions</b>	
<b>mounting position</b>	+/-180° rotation possible on vertical mounting surface; can be tilted forward and backward by +/- 22.5° on vertical mounting surface
<b>fastening method</b>	screw and snap-on mounting onto 35 mm DIN rail
<b>height</b>	68 mm
<b>width</b>	90 mm
<b>depth</b>	73 mm
<b>required spacing</b>	
● with side-by-side mounting	
— forwards	6 mm
— backwards	0 mm

— upwards	6 mm
— downwards	6 mm
— at the side	6 mm
• for grounded parts	
— forwards	6 mm
— backwards	0 mm
— upwards	6 mm
— at the side	6 mm
— downwards	6 mm
• for live parts	
— forwards	6 mm
— backwards	0 mm
— upwards	6 mm
— downwards	6 mm
— at the side	6 mm

### Connections/ Terminals

<b>type of electrical connection</b>	
• for main current circuit	screw-type terminals
• for auxiliary and control circuit	screw-type terminals
• at contactor for auxiliary contacts	Screw-type terminals
• of magnet coil	Screw-type terminals
type of connectable conductor cross-sections for main contacts	
• solid	2x (0.5 ... 1.5 mm <sup>2</sup> ), 2x (0.75 ... 2.5 mm <sup>2</sup> ), 2x 4 mm <sup>2</sup>
• solid or stranded	2x (0,5 ... 1,5 mm <sup>2</sup> ), 2x (0,75 ... 2,5 mm <sup>2</sup> ), 2x (0,5 ... 4 mm <sup>2</sup> )
• finely stranded with core end processing	2x (0.5 ... 1.5 mm <sup>2</sup> ), 2x (0.75 ... 2.5 mm <sup>2</sup> )
<b>type of connectable conductor cross-sections</b>	
• for auxiliary contacts	
— solid or stranded	2x (0.5 ... 1.5 mm <sup>2</sup> ), 2x (0.75 ... 2.5 mm <sup>2</sup> )
— finely stranded with core end processing	2x (0.5 ... 1.5 mm <sup>2</sup> ), 2x (0.75 ... 2.5 mm <sup>2</sup> )
• for AWG cables for auxiliary contacts	2x (20 ... 16), 2x (18 ... 14)





### Safety related data

product function suitable for safety function	Yes
Electrical Safety	
<b>protection class IP on the front according to IEC 60529</b>	IP20
<b>touch protection on the front according to IEC 60529</b>	finger-safe, for vertical contact from the front

### Communication/ Protocol



<b>product function bus communication</b>	Yes
protocol is supported AS-Interface protocol	No
product function control circuit interface with IO link	No

### Approvals Certificates

General Product Approval	Test Certificates
   	<a href="#">Type Test Certificates/Test Report</a> <a href="#">Special Test Certificate</a>

### Maritime application

     
---

Maritime application	other	Railway	Environment
		<a href="#">Confirmation</a>	<a href="#">Special Test Certificate</a> <a href="#">Environmental Confirmations</a>

## Further information

### Information on the packaging

<https://support.industry.siemens.com/cs/ww/en/view/109813875>

### Information for data generation and storage

<https://support.industry.siemens.com/cs/ww/en/view/109995012>

### Information- and Downloadcenter (Catalogs, Brochures,...)

<https://www.siemens.com/ic10>

### Industry Mall (Online ordering system)

<https://mall.industry.siemens.com/mall/en/en/Catalog/product?mlfb=3RA2318-8XB30-1AP6>

### Cax online generator

<https://support.automation.siemens.com/WW/CAXorder/default.aspx?lang=en&mlfb=3RA2318-8XB30-1AP6>

### Service&Support (Manuals, Certificates, Characteristics, FAQs,...)

<https://support.industry.siemens.com/cs/ww/en/ps/3RA2318-8XB30-1AP6>

### Image database (product images, 2D dimension drawings, 3D models, device circuit diagrams, EPLAN macros, ...)

[https://www.automation.siemens.com/bilddb/cax\\_de.aspx?mlfb=3RA2318-8XB30-1AP6&lang=en](https://www.automation.siemens.com/bilddb/cax_de.aspx?mlfb=3RA2318-8XB30-1AP6&lang=en)

### Characteristic: Tripping characteristics, I<sup>2</sup>t, Let-through current

<https://support.industry.siemens.com/cs/ww/en/ps/3RA2318-8XB30-1AP6/char>

### Further characteristics (e.g. electrical endurance, switching frequency)

<https://www.automation.siemens.com/bilddb/index.aspx?view=Search&mlfb=3RA2318-8XB30-1AP6&objecttype=14&gridview=view1>

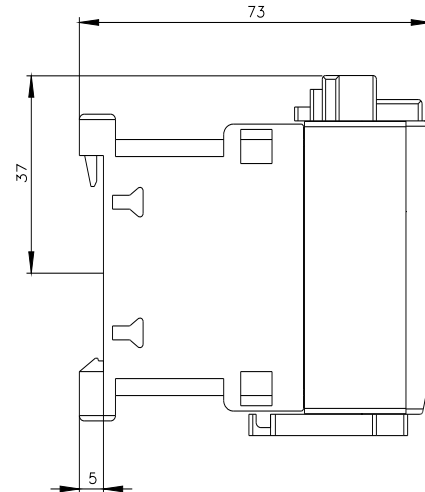
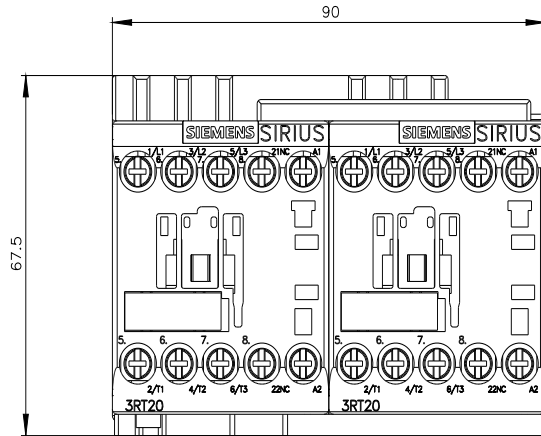

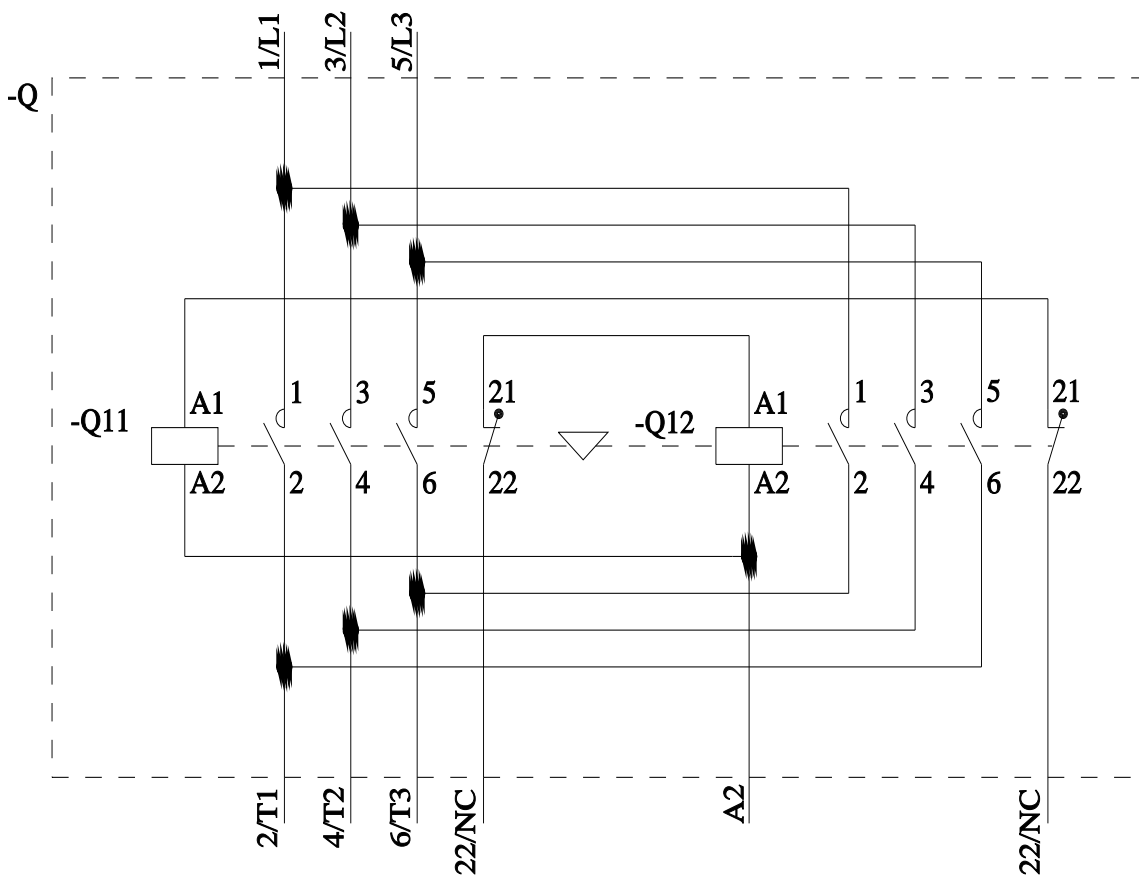

last modified:

5/9/2025