

Contactor assembly for star-delta (wye-delta) start AC-3, 5.5 kW/400 V, 110 V AC 50/60 Hz, 3-pole, Size S00 screw terminals electrical and mechanical interlock 3 NO integrated



product brand name	SIRIUS
product designation	Contactor assembly for star-delta (wye-delta) start
product type designation	3RA24
manufacturer's article number	
<ul style="list-style-type: none"> • 1 of the supplied contactor • 2 of the supplied contactor • 3 of the supplied contactor • of the supplied RS assembly kit • of the supplied function module for wye-delta circuits 	3RT2015-1AF01 3RT2015-1AF01 3RT2015-1AF01 3RA2913-2BB1 3RA2816-0EW20
General technical data	
size of contactor	S00
product extension auxiliary switch	No
shock resistance at rectangular impulse	
<ul style="list-style-type: none"> • at AC • at DC 	6,7g / 5 ms, 4,2g / 10 ms 6,7g / 5 ms, 4,2g / 10 ms
shock resistance with sine pulse	
<ul style="list-style-type: none"> • at AC • at DC 	10,5g / 5 ms, 6,6g / 10 ms 10,5g / 5 ms, 6,6g / 10 ms
mechanical service life (operating cycles)	
<ul style="list-style-type: none"> • of contactor typical • of the contactor with added auxiliary switch block typical 	10 000 000 10 000 000
reference code according to IEC 81346-2	Q
Substance Prohibition (Date)	10/01/2009
SVHC substance name	Lead - 7439-92-1 Lead monoxide (lead oxide) - 1317-36-8 6,6'-di-tert-butyl-2,2'-methylenedi-p-cresol - 119-47-1
Weight	1.089 kg
Ambient conditions	
installation altitude at height above sea level maximum	2 000 m
ambient temperature	
<ul style="list-style-type: none"> • during operation • during storage 	-25 ... +60 °C -55 ... +80 °C
Main circuit	
number of poles for main current circuit	3
number of NO contacts for main contacts	3
number of NC contacts for main contacts	0
operating voltage	
<ul style="list-style-type: none"> • at AC-3 rated value maximum 	690 V
operational current	
<ul style="list-style-type: none"> • at AC-3 — at 400 V rated value 	12 A

operating power	
<ul style="list-style-type: none"> ● at AC-3 <ul style="list-style-type: none"> — at 400 V rated value — at 500 V rated value — at 690 V rated value 	<p>5.5 kW</p> <p>7.2 kW</p> <p>9.2 kW</p>
operating frequency	
<ul style="list-style-type: none"> ● at AC-3 maximum 	1 000 1/h
Control circuit/ Control	
type of voltage of the control supply voltage	AC
control supply voltage 1 at AC	
<ul style="list-style-type: none"> ● at 50 Hz rated value ● at 60 Hz rated value 	<p>110 V</p> <p>110 V</p>
operating range factor control supply voltage rated value of magnet coil at AC	
<ul style="list-style-type: none"> ● at 50 Hz ● at 60 Hz 	<p>0.8 ... 1.1</p> <p>0.85 ... 1.1</p>
apparent pick-up power of magnet coil at AC	
<ul style="list-style-type: none"> ● at 50 Hz ● at 60 Hz 	<p>56 VA</p> <p>51 VA</p>
inductive power factor with closing power of the coil	
<ul style="list-style-type: none"> ● at 50 Hz ● at 60 Hz 	<p>0.8</p> <p>0.75</p>
apparent holding power of magnet coil at AC	
<ul style="list-style-type: none"> ● at 50 Hz ● at 60 Hz 	<p>10.4 VA</p> <p>8.6 VA</p>
inductive power factor with the holding power of the coil	
<ul style="list-style-type: none"> ● at 50 Hz ● at 60 Hz 	<p>0.25</p> <p>0.25</p>
Auxiliary circuit	
number of NO contacts for auxiliary contacts	
<ul style="list-style-type: none"> ● instantaneous contact 	3
contact reliability of auxiliary contacts	< 1 error per 100 million operating cycles
UL/CSA ratings	
contact rating of auxiliary contacts according to UL	A600 / Q600
Short-circuit protection	
design of the fuse link	
<ul style="list-style-type: none"> ● for short-circuit protection of the main circuit <ul style="list-style-type: none"> — with type of coordination 1 required — with type of coordination 2 required ● for short-circuit protection of the auxiliary switch required 	<p>gG NH 3NA, DIAZED 5SB, NEOZED 5SE: 35 A</p> <p>gG NH 3NA, DIAZED 5SB, NEOZED 5SE: 20 A</p> <p>fuse gG: 10 A</p>
Installation/ mounting/ dimensions	
mounting position	+/-180° rotation possible on vertical mounting surface; can be tilted forward and backward by +/- 22.5° on vertical mounting surface
fastening method	screw and snap-on mounting onto 35 mm DIN rail
height	68 mm
width	135 mm
depth	145 mm
required spacing	
<ul style="list-style-type: none"> ● with side-by-side mounting <ul style="list-style-type: none"> — forwards — backwards — upwards — downwards — at the side ● for grounded parts <ul style="list-style-type: none"> — forwards — backwards — upwards — at the side — downwards ● for live parts 	<p>6 mm</p> <p>0 mm</p> <p>6 mm</p> <p>6 mm</p> <p>6 mm</p> <p>6 mm</p> <p>6 mm</p> <p>0 mm</p> <p>6 mm</p> <p>6 mm</p> <p>6 mm</p>

— forwards	6 mm
— backwards	0 mm
— upwards	6 mm
— downwards	6 mm
— at the side	6 mm

Connections/ Terminals

type of electrical connection	
<ul style="list-style-type: none"> • for main current circuit • for auxiliary and control circuit • at contactor for auxiliary contacts • of magnet coil 	screw-type terminals screw-type terminals Screw-type terminals Screw-type terminals
type of connectable conductor cross-sections for main contacts	
<ul style="list-style-type: none"> • solid • solid or stranded • finely stranded with core end processing 	2x (0.5 ... 1.5 mm ²), 2x (0.75 ... 2.5 mm ²), 2x 4 mm ² 2x (0.5 ... 1.5 mm ²), 2x (0.75 ... 2.5 mm ²), 2x (0.5 ... 4 mm ²) 2x (0.5 ... 1.5 mm ²), 2x (0.75 ... 2.5 mm ²)
type of connectable conductor cross-sections	
<ul style="list-style-type: none"> • for auxiliary contacts <ul style="list-style-type: none"> — solid or stranded — finely stranded with core end processing • for AWG cables for auxiliary contacts 	2x (0.5 ... 1.5 mm ²), 2x (0.75 ... 2.5 mm ²) 2x (0.5 ... 1.5 mm ²), 2x (0.75 ... 2.5 mm ²) 2x (20 ... 16), 2x (18 ... 14)

Safety related data

product function suitable for safety function	Yes
Electrical Safety	
protection class IP on the front according to IEC 60529	IP20
touch protection on the front according to IEC 60529	finger-safe, for vertical contact from the front

Communication/ Protocol

product function bus communication	No
protocol is supported AS-Interface protocol	No
product function control circuit interface with IO link	No

Approvals Certificates

General Product Approval	Test Certificates	Maritime application
--------------------------	-------------------	----------------------



[Special Test Certificate](#)

[Type Test Certificates/Test Report](#)



Maritime application



other	Railway	Environment
-------	---------	-------------



[Confirmation](#)

[Special Test Certificate](#)

[Environmental Confirmations](#)

Further information

Information on the packaging

<https://support.industry.siemens.com/cs/ww/en/view/109813875>

Information for data generation and storage

<https://support.industry.siemens.com/cs/ww/en/view/109995012>

Information- and Downloadcenter (Catalogs, Brochures,...)

<https://www.siemens.com/ic10>

Industry Mall (Online ordering system)

<https://mall.industry.siemens.com/mall/en/en/Catalog/product?mlfb=3RA2415-8XF31-1AF0>

Cax online generator

<https://support.automation.siemens.com/WW/CAXorder/default.aspx?lang=en&mlfb=3RA2415-8XF31-1AF0>

Service&Support (Manuals, Certificates, Characteristics, FAQs,...)

<https://support.industry.siemens.com/cs/ww/en/ps/3RA2415-8XF31-1AF0>

Image database (product images, 2D dimension drawings, 3D models, device circuit diagrams, EPLAN macros, ...)

https://www.automation.siemens.com/bilddb/cax_de.aspx?mlfb=3RA2415-8XF31-1AF0&lang=en

Characteristic: Tripping characteristics, I²t, Let-through current

<https://support.industry.siemens.com/cs/ww/en/ps/3RA2415-8XF31-1AF0/char>

Further characteristics (e.g. electrical endurance, switching frequency)

<https://www.automation.siemens.com/bilddb/index.aspx?view=Search&mlfb=3RA2415-8XF31-1AF0&objecttype=14&gridview=view1>

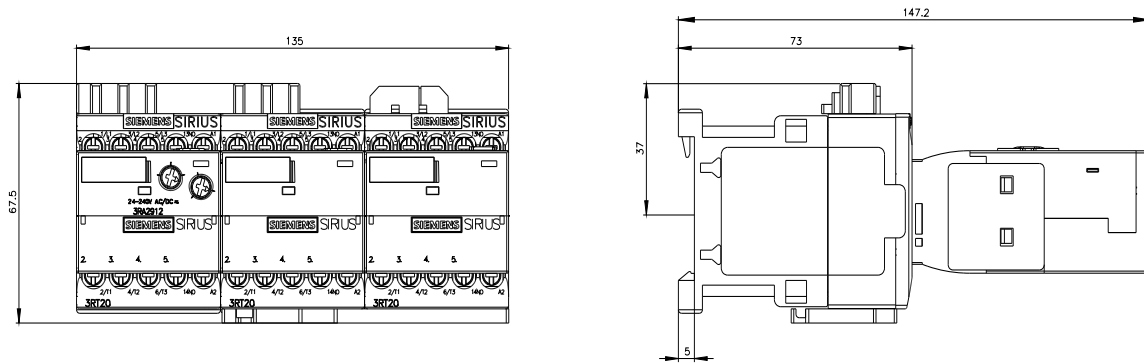

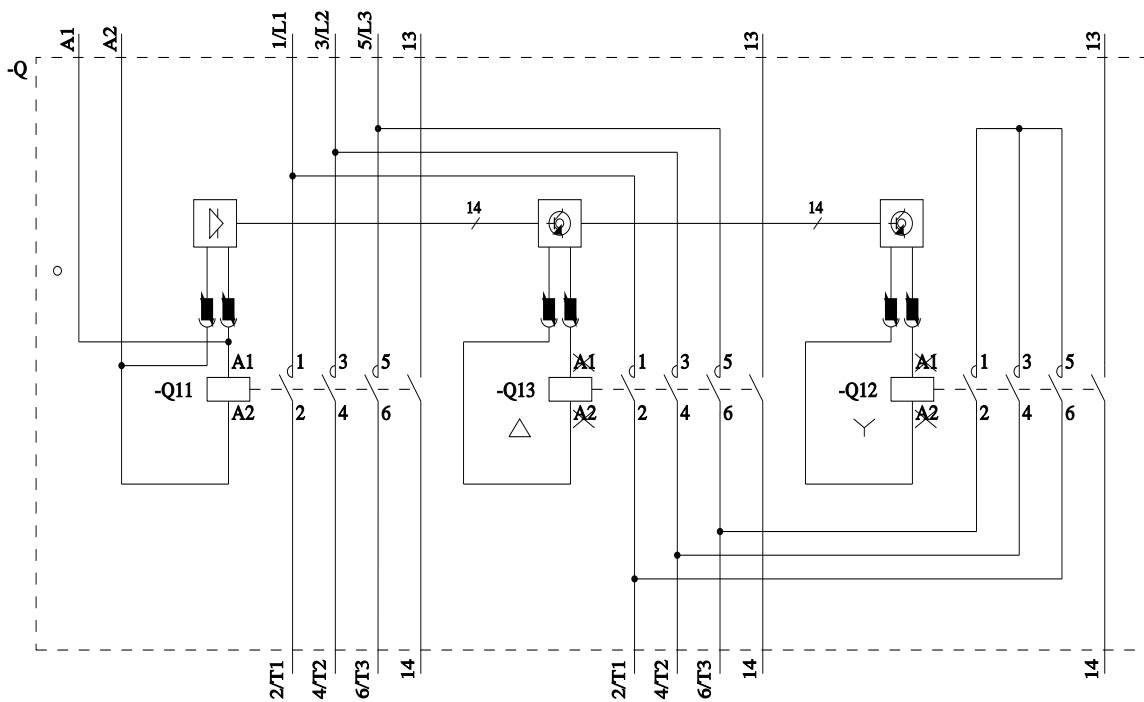
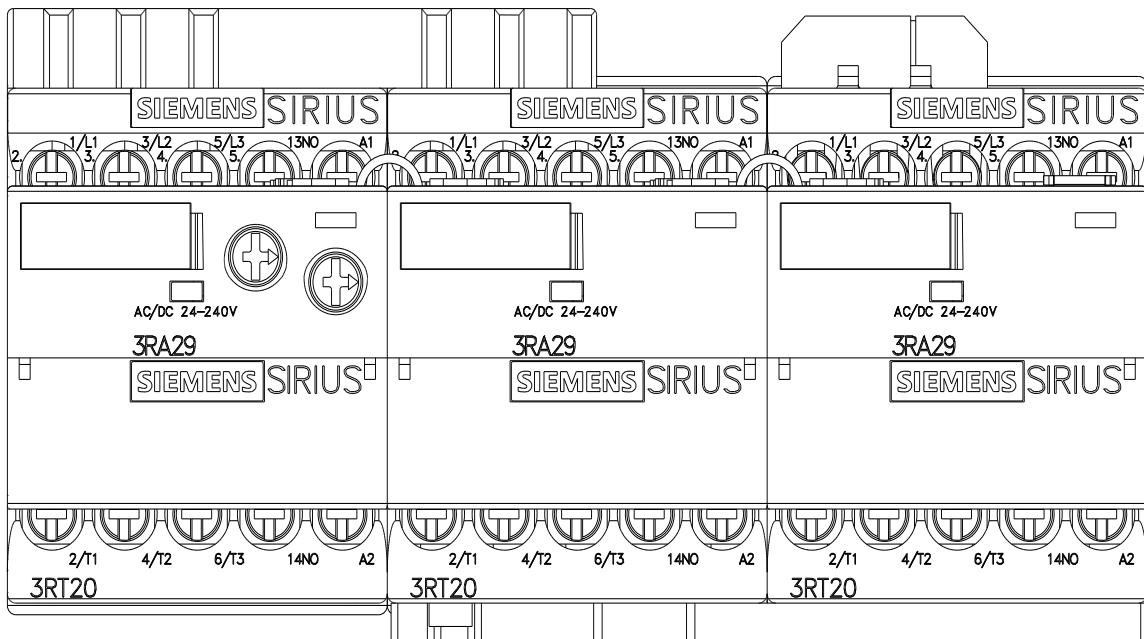

last modified:

5/9/2025