

Contactor assembly for star-delta (wye-delta) start AC-3, 15/18.5 kW/400 V, 24 V DC 3-pole, Size S0 Spring-type terminal electrical and mechanical interlock 3 NO + 3 NC integrated



product brand name	SIRIUS
product designation	Contactor assembly for star-delta (wye-delta) start
product type designation	3RA24
manufacturer's article number	<ul style="list-style-type: none"> • 1 of the supplied contactor 3RT2026-2BB40 • 2 of the supplied contactor 3RT2026-2BB40 • 3 of the supplied contactor 3RT2024-2BB40 • of the supplied RS assembly kit 3RA2923-2BB2 • of the supplied function module for wye-delta circuits 3RA2816-0EW20
General technical data	
size of contactor	S0
product extension auxiliary switch	No
shock resistance at rectangular impulse	<ul style="list-style-type: none"> • at AC 7,5g / 5 ms, 4,7g / 10 ms • at DC 10g / 5 ms, 7,5g / 10 ms
shock resistance with sine pulse	<ul style="list-style-type: none"> • at AC 11,8g / 5 ms, 7,4g / 10 ms • at DC 15g / 5 ms, 10g / 10 ms
mechanical service life (operating cycles)	<ul style="list-style-type: none"> • of contactor typical 10 000 000 • of the contactor with added auxiliary switch block typical 10 000 000
reference code according to IEC 81346-2	Q
Substance Prohibition (Date)	10/01/2009
SVHC substance name	Lead - 7439-92-1 Lead monoxide (lead oxide) - 1317-36-8 6,6'-di-tert-butyl-2,2'-methylenedi-p-cresol - 119-47-1
Weight	2.6 kg
Ambient conditions	
installation altitude at height above sea level maximum	2 000 m
ambient temperature	<ul style="list-style-type: none"> • during operation -25 ... +60 °C • during storage -55 ... +80 °C
Main circuit	
number of poles for main current circuit	3
number of NO contacts for main contacts	3
number of NC contacts for main contacts	0
operating voltage	<ul style="list-style-type: none"> • at AC-3 rated value maximum 690 V
operational current	<ul style="list-style-type: none"> • at AC-3 — at 400 V rated value 40 A

operating power	
<ul style="list-style-type: none"> ● at AC-3 <ul style="list-style-type: none"> — at 400 V rated value — at 500 V rated value — at 690 V rated value 	15 kW 19 kW 19 kW
operating frequency	
<ul style="list-style-type: none"> ● at AC-3 maximum 	1 000 1/h
Control circuit/ Control	
type of voltage of the control supply voltage	DC
control supply voltage 1 at DC rated value	24 V
closing power of magnet coil at DC	13.8 W
holding power of magnet coil at DC	13.8 W
Auxiliary circuit	
number of NC contacts for auxiliary contacts	
<ul style="list-style-type: none"> ● instantaneous contact 	3
number of NO contacts for auxiliary contacts	
<ul style="list-style-type: none"> ● instantaneous contact 	3
contact reliability of auxiliary contacts	< 1 error per 100 million operating cycles
UL/CSA ratings	
contact rating of auxiliary contacts according to UL	A600 / Q600
Short-circuit protection	
design of the fuse link	
<ul style="list-style-type: none"> ● for short-circuit protection of the main circuit <ul style="list-style-type: none"> — with type of coordination 1 required — with type of coordination 2 required ● for short-circuit protection of the auxiliary switch required 	gG NH 3NA, DIAZED 5SB, NEOZED 5SE: 100 A gG NH 3NA, DIAZED 5SB, NEOZED 5SE: 35 A fuse gG: 10 A
Installation/ mounting/ dimensions	
mounting position	+/-180° rotation possible on vertical mounting surface; can be tilted forward and backward by +/- 22.5° on vertical mounting surface
fastening method	screw and snap-on mounting onto 35 mm DIN rail
height	114 mm
width	135 mm
depth	181 mm
required spacing	
<ul style="list-style-type: none"> ● with side-by-side mounting <ul style="list-style-type: none"> — forwards — backwards — upwards — downwards — at the side ● for grounded parts <ul style="list-style-type: none"> — forwards — backwards — upwards — at the side — downwards ● for live parts <ul style="list-style-type: none"> — forwards — backwards — upwards — downwards — at the side 	6 mm 0 mm 6 mm 6 mm 6 mm 6 mm 6 mm 0 mm 6 mm 6 mm 6 mm 6 mm 0 mm 6 mm 6 mm 6 mm
Connections/ Terminals	
type of electrical connection	
<ul style="list-style-type: none"> ● for main current circuit ● for auxiliary and control circuit ● at contactor for auxiliary contacts ● of magnet coil 	spring-loaded terminals spring-loaded terminals Spring-type terminals Spring-type terminals
type of connectable conductor cross-sections for main contacts	
<ul style="list-style-type: none"> ● solid ● solid or stranded 	2x (1 ... 10 mm ²) 2x (1 ... 10 mm ²)

<ul style="list-style-type: none"> finely stranded with core end processing finely stranded without core end processing 	<p>2x (1 ... 6 mm²)</p> <p>2x (1 ... 6 mm²)</p>
type of connectable conductor cross-sections <ul style="list-style-type: none"> for auxiliary contacts <ul style="list-style-type: none"> — solid or stranded — finely stranded with core end processing — finely stranded without core end processing for AWG cables for auxiliary contacts 	<p>2x (0.5 ... 2.5 mm²)</p> <p>2x (0.5 ... 1.5 mm²)</p> <p>2x (0.5 ... 1.5 mm²)</p> <p>2x (20 ... 14)</p>





Safety related data

product function suitable for safety function	Yes
Electrical Safety	
protection class IP on the front according to IEC 60529	IP20
touch protection on the front according to IEC 60529	finger-safe, for vertical contact from the front

Communication/ Protocol

product function bus communication	No
protocol is supported AS-Interface protocol	No
product function control circuit interface with IO link	No

Approvals Certificates

General Product Approval	Test Certificates	Maritime application
  	Special Test Certificate	 

Maritime application	other
    	

other	Railway	Dangerous goods	Environment
Confirmation	Special Test Certificate	Transport Information	Environmental Confirmations

Further information

Information on the packaging
<https://support.industry.siemens.com/cs/ww/en/view/109813875>

Information for data generation and storage
<https://support.industry.siemens.com/cs/ww/en/view/109995012>

Information- and Downloadcenter (Catalogs, Brochures,...)
<https://www.siemens.com/ic10>

Industry Mall (Online ordering system)
<https://mall.industry.siemens.com/mall/en/en/Catalog/product?mlfb=3RA2425-8XF32-2BB4>

Cax online generator
<https://support.automation.siemens.com/WW/CAXorder/default.aspx?lang=en&mlfb=3RA2425-8XF32-2BB4>

Service&Support (Manuals, Certificates, Characteristics, FAQs,...)
<https://support.industry.siemens.com/cs/ww/en/ps/3RA2425-8XF32-2BB4>

Image database (product images, 2D dimension drawings, 3D models, device circuit diagrams, EPLAN macros, ...)
https://www.automation.siemens.com/bilddb/cax_de.aspx?mlfb=3RA2425-8XF32-2BB4&lang=en

Characteristic: Tripping characteristics, I²t, Let-through current
<https://support.industry.siemens.com/cs/ww/en/ps/3RA2425-8XF32-2BB4/char>

Further characteristics (e.g. electrical endurance, switching frequency)
<https://www.automation.siemens.com/bilddb/index.aspx?view=Search&mlfb=3RA2425-8XF32-2BB4&objecttype=14&gridview=view1>

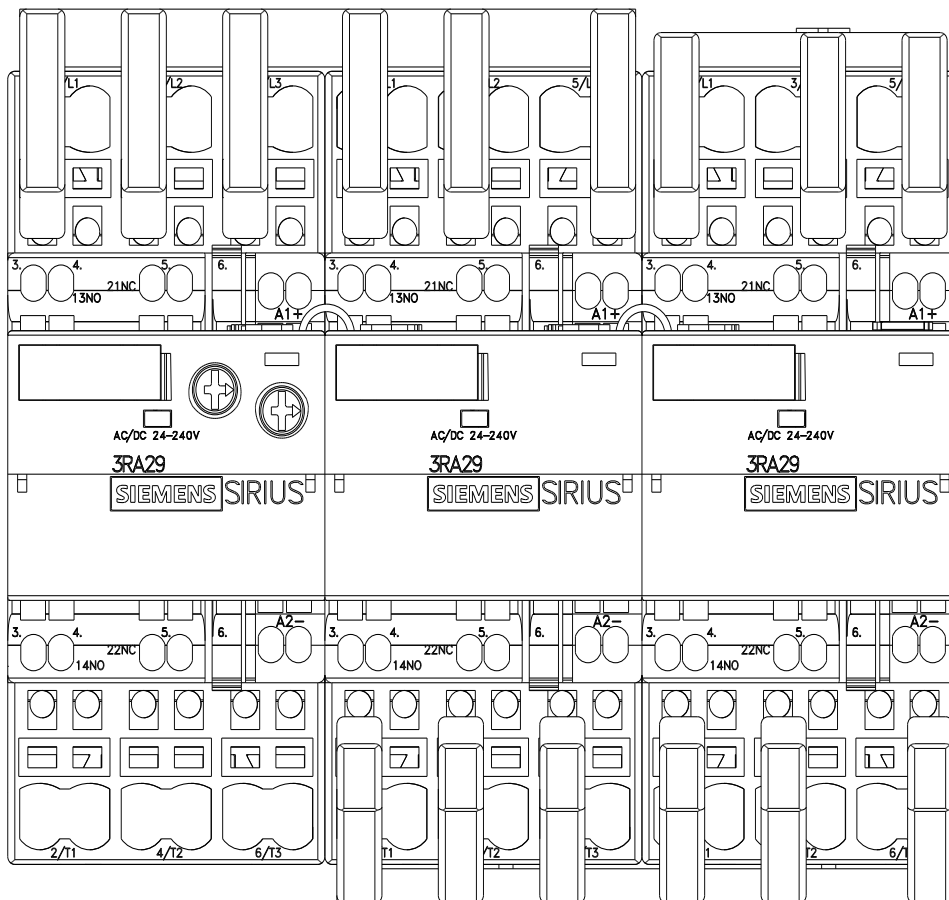
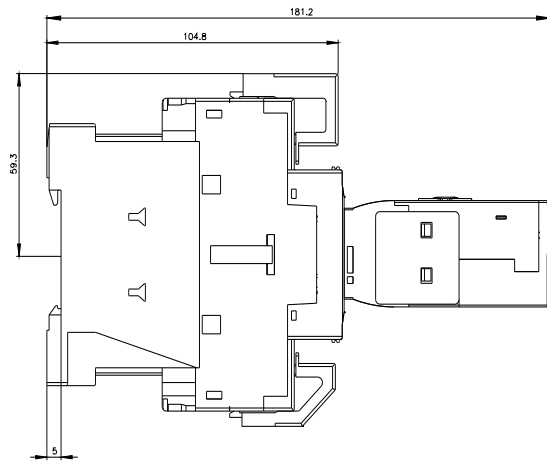
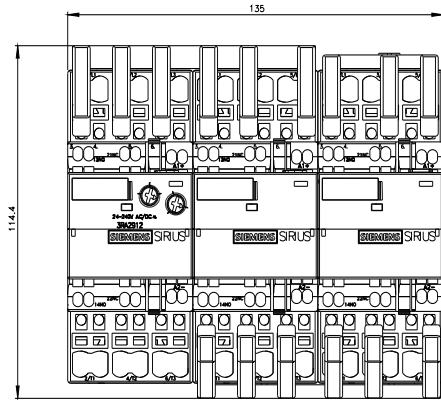

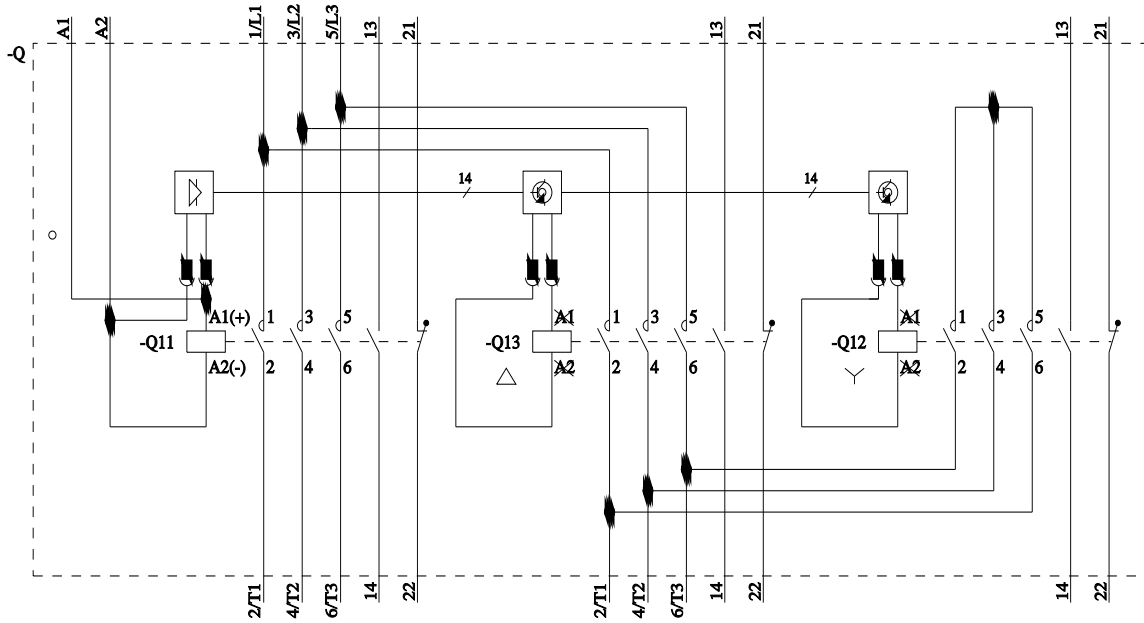

last modified:

8/8/2025 