







semiconductor relay, 3-phase 3RF2 30 A / 40 °C 48-600 V / 110 V AC 2-phase controlled screw terminal blocking voltage 1200 V for mounting on available cooling surfaces

product brand name	SIRIUS
product designation	solid-state relay
design of the product	2-pole controlled
product type designation	3RF22
General technical data	
product function	zero-point switching
power loss [W] for rated value of the current	
• at AC in hot operating state	81 W
• at AC in hot operating state per pole	81 W
• without load current share typical	1.8 W
insulation voltage rated value	600 V
surge voltage resistance of main circuit rated value	6 kV
protection class IP	IP20
protection class IP on the front according to IEC 60529	IP20
shock resistance according to IEC 60068-2-27	15g / 11 ms
vibration resistance according to IEC 60068-2-6	2g
reference code according to IEC 81346-2	Q
Substance Prohibitance (Date)	07/01/2006
SVHC substance name	Lead - 7439-92-1 Lead monoxide (lead oxide) - 1317-36-8
Weight	0.145 kg
Main circuit	
number of poles for main current circuit	3
number of NO contacts for main contacts	2
number of NC contacts for main contacts	0
type of voltage of the operating voltage	AC
operating voltage	
• at AC	
— at 50 Hz rated value	48 ... 600 V
— at 60 Hz rated value	48 ... 600 V
operating frequency rated value	50 ... 60 Hz
relative symmetrical tolerance of the operating frequency	10 %
operating range relative to the operating voltage at AC	
• at 50 Hz	40 ... 660 V
• at 60 Hz	40 ... 660 V
operational current rated value maximum	30 A
operational current	
• at AC-51 rated value	30 A
• according to UL 508 rated value	30 A
operational current minimum	500 mA

rate of voltage rise at the thyristor for main contacts maximum permissible	500 V/ μ s
blocking voltage at the thyristor for main contacts maximum permissible	1 200 V
reverse current of the thyristor	10 mA
derating temperature	40 °C
surge current resistance rated value	300 A
I ² t value maximum	450 A ² ·s
Control circuit/ Control	
type of voltage of the control supply voltage	AC
control supply voltage 1 at AC	
• at 50 Hz	88 ... 121 V
• at 60 Hz	88 ... 121 V
control supply voltage frequency	
• 1 rated value	50 Hz
• 2 rated value	60 Hz
control supply voltage at AC	
• at 50 Hz full-scale value for signal<0> recognition	40 V
• at 60 Hz full-scale value for signal<0> recognition	40 V
control supply voltage	
• at AC initial value for signal <1> detection	90 V
control current at minimum control supply voltage	
• at AC	2 mA
control current at AC rated value	15 mA
ON-delay time	40 ms
OFF-delay time	40 ms; additionally max. one half-wave
Auxiliary circuit	
type of switching contact	normally open contact (NO)
number of NC contacts for auxiliary contacts	0
number of NO contacts for auxiliary contacts	0
number of CO contacts for auxiliary contacts	0
Installation/ mounting/ dimensions	
fastening method side-by-side mounting	Yes
fastening method	screw fixing
design of the thread of the screw for securing the equipment	M4
tightening torque of fixing screw maximum	1.5 N·m
tightening torque [lbf·in] of fixing screw maximum	13 lbf·in
height	95 mm
width	45 mm
depth	47 mm
Connections/ Terminals	
product component removable terminal for auxiliary and control circuit	Yes
type of electrical connection	
• for main current circuit	screw-type terminals
• for auxiliary and control circuit	screw-type terminals
type of connectable conductor cross-sections	
• for main contacts	
— solid	2x (1.5 ... 2.5 mm ²), 2x (2.5 ... 6 mm ²)
— finely stranded with core end processing	2x (1 ... 2.5 mm ²), 2x (2.5 ... 6 mm ²), 1x 10 mm ²
• for AWG cables for main contacts	2x (14 ... 10)
connectable conductor cross-section for main contacts	
• solid or stranded	1.5 ... 6 mm ²
• finely stranded with core end processing	1 ... 10 mm ²
type of connectable conductor cross-sections	
• for auxiliary and control contacts	
— solid	1x (0.5 ... 2.5 mm ²), 2x (0.5 ... 1 mm ²)
— finely stranded with core end processing	1x (0.5 ... 2.5 mm ²), 2x (0.5 ... 1 mm ²)
— finely stranded without core end processing	1x (0.5 ... 2.5 mm ²), 2x (0.5 ... 1 mm ²)
• for AWG cables for auxiliary and control contacts	1x (20 ... 12)
AWG number as coded connectable conductor cross	10 ... 14

section for main contacts			
tightening torque			
<ul style="list-style-type: none"> • for main contacts with screw-type terminals • for auxiliary and control contacts with screw-type terminals 	<p>2 ... 2.5 N·m</p> <p>0.5 ... 0.6 N·m</p>		
tightening torque [lbf·in]			
<ul style="list-style-type: none"> • for main contacts with screw-type terminals • for auxiliary and control contacts with screw-type terminals 	<p>18 ... 22 lbf·in</p> <p>4.5 ... 5.3 lbf·in</p>		
design of the thread of the connection screw			
<ul style="list-style-type: none"> • for main contacts • of the auxiliary and control contacts 	<p>M4</p> <p>M3</p>		
stripped length of the cable			
<ul style="list-style-type: none"> • for main contacts • for auxiliary and control contacts 	<p>10 mm</p> <p>7 mm</p>		
Electrical Safety			
protection class IP on the front according to IEC 60529	IP20		
touch protection on the front according to IEC 60529	finger-safe, for vertical contact from the front		
Ambient conditions			
installation altitude at height above sea level maximum	1 000 m		
ambient temperature			
<ul style="list-style-type: none"> • during operation • during storage 	<p>-25 ... +60 °C</p> <p>-55 ... +80 °C</p>		
Electromagnetic compatibility			
conducted interference			
<ul style="list-style-type: none"> • due to burst according to IEC 61000-4-4 • due to conductor-earth surge according to IEC 61000-4-5 • due to conductor-conductor surge according to IEC 61000-4-5 • due to high-frequency radiation according to IEC 61000-4-6 	<p>2 kV / 5 kHz behavior criterion 2</p> <p>2 kV behavior criterion 2</p> <p>1 kV behavior criterion 2</p> <p>140 dBuV in the frequency range 0.15 ... 80 MHz, behavior criterion 1</p>		
electrostatic discharge according to IEC 61000-4-2	4 kV contact discharging / 8 kV air discharging, behavior criterion 2		
conducted HF interference emissions according to CISPR11	Class A for industrial environment		
field-bound HF interference emission according to CISPR11	Class A for industrial environment		
Short-circuit protection, design of the fuse link			
<p>manufacturer's article number</p> <ul style="list-style-type: none"> • of full range R fuse link for semiconductor protection at NH design usable • of back-up R fuse link for semiconductor protection at NH design usable • of back-up R fuse link for semiconductor protection at cylindrical design 10 x 38 mm usable • of back-up R fuse link for semiconductor protection at cylindrical design 14 x 51 mm usable • of back-up R fuse link for semiconductor protection at cylindrical design 22 x 58 mm usable 	<p>3NE1814-0; These fuses have a smaller rated current than the semiconductor relays</p> <p>3NE8003-1</p> <p>3NC1025; These fuses have a smaller rated current than the semiconductor relays</p> <p>3NC1430</p> <p>3NC2232</p>		
<p>manufacturer's article number of the gG fuse at NH design usable</p> <ul style="list-style-type: none"> • up to 460 V • up to 600 V 	<p>3NA3803-6; These fuses have a smaller rated current than the semiconductor relays</p> <p>3NA3803-6; These fuses have a smaller rated current than the semiconductor relays</p>		
Approvals Certificates			
General Product Approval	EMV	Test Certificates	other
			
		Type Test Certificates/Test Report	Confirmation
other	Environment		



Environmental Con-
firmations

Further information

Information on the packaging

<https://support.industry.siemens.com/cs/ww/en/view/109813875>

Information for data generation and storage

<https://support.industry.siemens.com/cs/ww/en/view/109995012>

Information- and Downloadcenter (Catalogs, Brochures,...)

<https://www.siemens.com/ic10>

Industry Mall (Online ordering system)

<https://mall.industry.siemens.com/mall/en/en/Catalog/product?mlfb=3RF2230-1AB35>

Cax online generator

<https://support.automation.siemens.com/WW/CAXorder/default.aspx?lang=en&mlfb=3RF2230-1AB35>

Service&Support (Manuals, Certificates, Characteristics, FAQs,...)

<https://support.industry.siemens.com/cs/ww/en/ps/3RF2230-1AB35>

Image database (product images, 2D dimension drawings, 3D models, device circuit diagrams, EPLAN macros, ...)

https://www.automation.siemens.com/bilddb/cax_de.aspx?mlfb=3RF2230-1AB35&lang=en

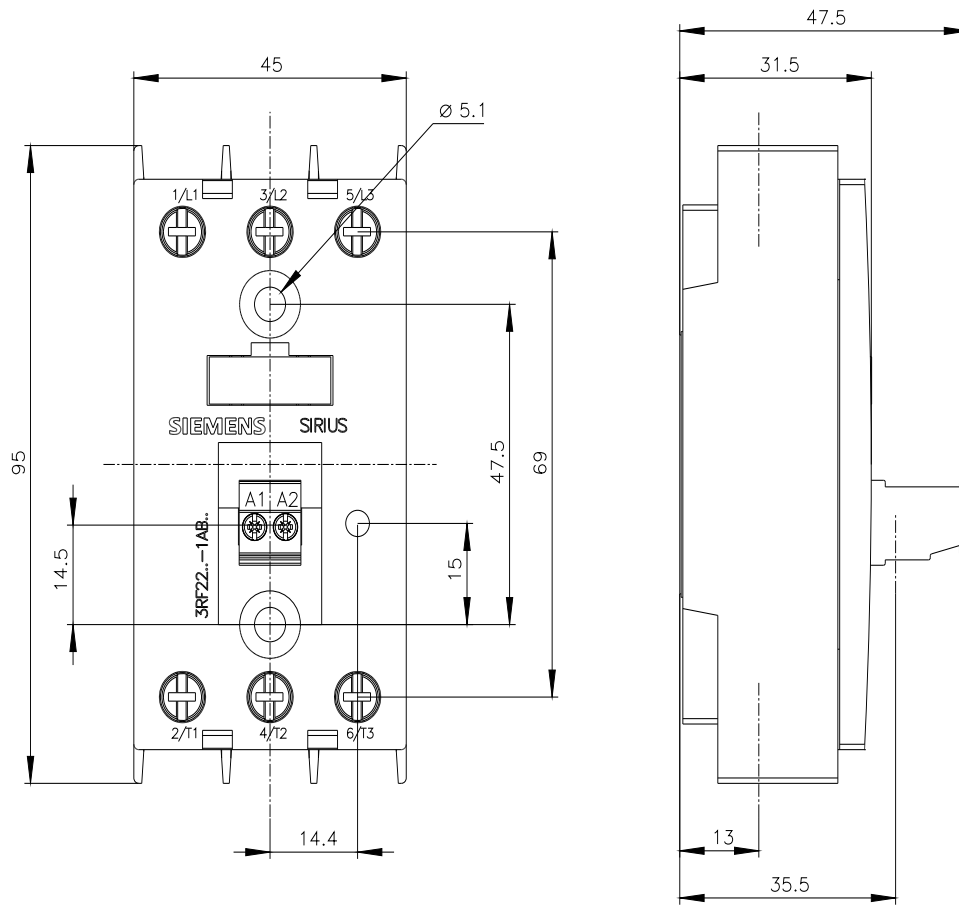

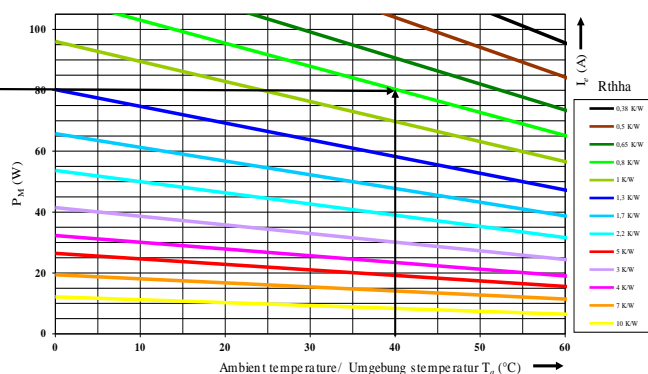
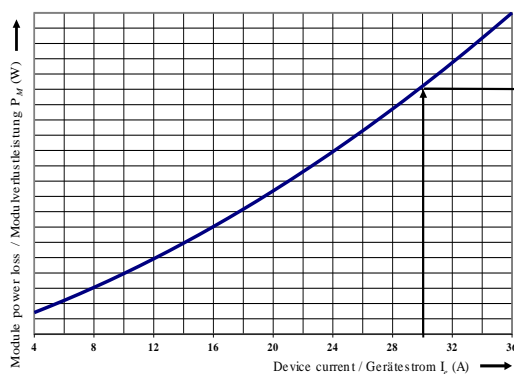
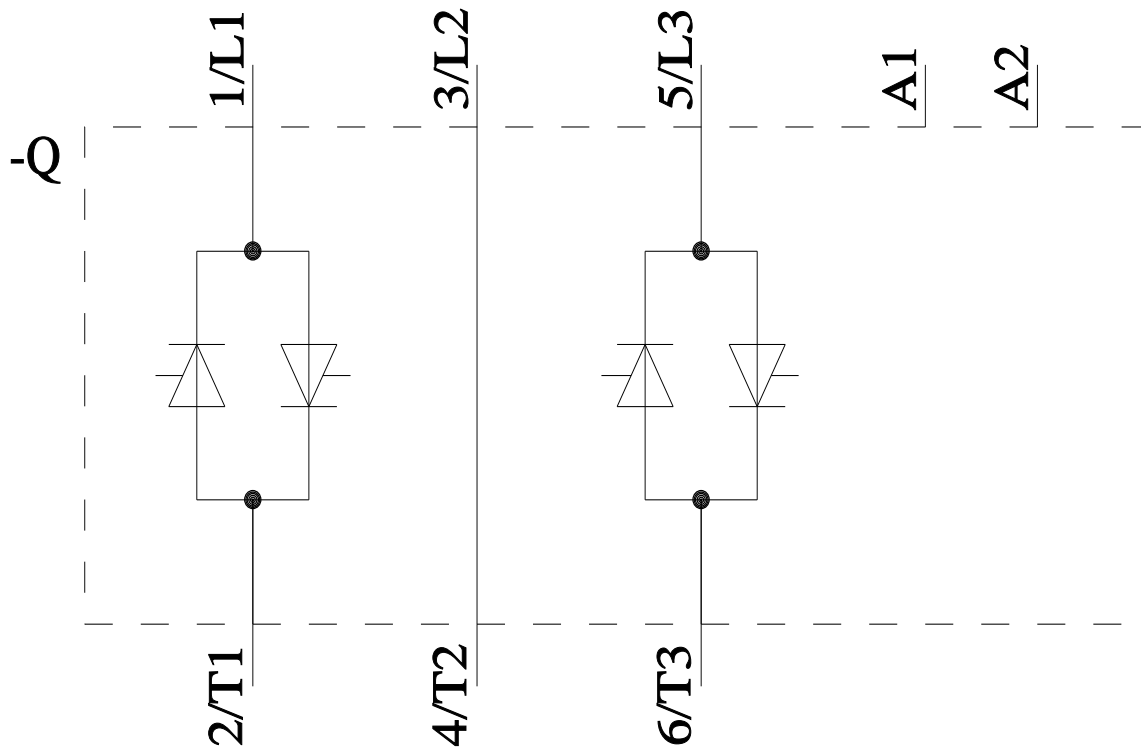

last modified:

8/4/2025 ↻