



Solid-state contactor 1-phase 3RF2 AC 51 / 30 A / 40 °C 48-600 V / 4-30 V DC screw terminal Blocking voltage 1200 V

product brand name	SIRIUS
product designation	solid-state contactor
design of the product	1-pole
product type designation	3RF23
manufacturer's article number	
<ul style="list-style-type: none"> • _1 of the accessories that can be ordered • _2 of the accessories that can be ordered • _3 of the accessories that can be ordered • _4 of the accessories that can be ordered • _5 of the accessories that can be ordered 	3RF2900-3PA88 3RF2950-0HA16 3RF2900-0EA18 3RF2950-0GA16 3RF2920-0FA08
product designation	
<ul style="list-style-type: none"> • _1 of the accessories that can be ordered • _2 of the accessories that can be ordered • _3 of the accessories that can be ordered • _4 of the accessories that can be ordered • _5 of the accessories that can be ordered 	terminal cover power regulator converter load monitoring load monitoring, basis
General technical data	
product function	zero-point switching
power loss [W] for rated value of the current	
<ul style="list-style-type: none"> • at AC in hot operating state • at AC in hot operating state per pole • without load current share typical 	33 W 33 W 0.6 W
insulation voltage rated value	600 V
degree of pollution	3
surge voltage resistance of main circuit rated value	6 kV
protection class IP	IP20
protection class IP on the front according to IEC 60529	IP20
shock resistance according to IEC 60068-2-27	15g / 11 ms
vibration resistance according to IEC 60068-2-6	2g
reference code according to IEC 81346-2	Q
Substance Prohibitance (Date)	05/28/2009
SVHC substance name	Lead - 7439-92-1 Lead monoxide (lead oxide) - 1317-36-8 Dibutylbis(pentane-2,4-dionato-O,O')tin - 22673-19-4
Weight	0.3 kg
Main circuit	
number of poles for main current circuit	1
number of NO contacts for main contacts	1
number of NC contacts for main contacts	0
type of voltage of the operating voltage	AC
operating voltage	







<ul style="list-style-type: none"> • at AC <ul style="list-style-type: none"> — at 50 Hz rated value — at 60 Hz rated value 	48 ... 600 V 48 ... 600 V
operating frequency rated value	50 ... 60 Hz
operating range relative to the operating voltage at AC <ul style="list-style-type: none"> • at 50 Hz • at 60 Hz 	40 ... 660 V 40 ... 660 V
operational current <ul style="list-style-type: none"> • at AC-51 rated value • at AC-51 according to IEC 60947-4-3 • according to UL 508 rated value 	30 A 22 A 27 A
operational current minimum	500 mA
rate of voltage rise at the thyristor for main contacts maximum permissible	1 000 V/ μ s
blocking voltage at the thyristor for main contacts maximum permissible	1 200 V
reverse current of the thyristor	10 mA
derating temperature	40 °C
surge current resistance rated value	600 A
I²t value maximum	1 800 A ² ·s
Control circuit/ Control	
type of voltage of the control supply voltage	DC
control supply voltage 1 at DC rated value maximum permissible	30 V
control supply voltage 1 at DC	4 ... 30 V
control supply voltage <ul style="list-style-type: none"> • at DC initial value for signal <1> detection • at DC full-scale value for signal<0> recognition 	4 V 1 V
control current at minimum control supply voltage <ul style="list-style-type: none"> • at DC 	18 mA
control current at DC rated value	20 mA
ON-delay time	1 ms; additionally max. one half-wave
OFF-delay time	1 ms; additionally max. one half-wave
Auxiliary circuit	
type of switching contact	normally open contact (NO)
number of NC contacts for auxiliary contacts	0
number of NO contacts for auxiliary contacts	0
number of CO contacts for auxiliary contacts	0
Installation/ mounting/ dimensions	
fastening method side-by-side mounting	Yes
fastening method	screw fixing and snap-on mounting on standard mounting rail 35 mm according to IEC 60715
design of the thread of the screw for securing the equipment	M4
height	95 mm
width	45 mm
depth	135.5 mm
Connections/ Terminals	
product component removable terminal for auxiliary and control circuit	Yes
type of electrical connection <ul style="list-style-type: none"> • for main current circuit • for auxiliary and control circuit 	screw-type terminals screw-type terminals
type of connectable conductor cross-sections <ul style="list-style-type: none"> • for main contacts <ul style="list-style-type: none"> — solid — finely stranded with core end processing • for AWG cables for main contacts 	2x (1.5 ... 2.5 mm ²), 2x (2.5 ... 6 mm ²) 2x (1 ... 2.5 mm ²), 2x (2.5 ... 6 mm ²), 1x 10 mm ² 2x (14 ... 10)
connectable conductor cross-section for main contacts <ul style="list-style-type: none"> • solid or stranded • finely stranded with core end processing 	1.5 ... 6 mm ² 1 ... 10 mm ²
type of connectable conductor cross-sections	

<ul style="list-style-type: none"> • for auxiliary and control contacts <ul style="list-style-type: none"> — solid — finely stranded with core end processing — finely stranded without core end processing • for AWG cables for auxiliary and control contacts 	1x (0.5 ... 2.5 mm ²), 2x (0.5 ... 1 mm ²) 1x (0.5 ... 2.5 mm ²), 2x (0.5 ... 1 mm ²) 1x (0.5 ... 2.5 mm ²), 2x (0.5 ... 1 mm ²) 1x (20 ... 12)
AWG number as coded connectable conductor cross section for main contacts	10 ... 14
tightening torque	
<ul style="list-style-type: none"> • for main contacts with screw-type terminals • for auxiliary and control contacts with screw-type terminals 	2 ... 2.5 N·m 0.5 ... 0.6 N·m
tightening torque [lbf·in]	
<ul style="list-style-type: none"> • for main contacts with screw-type terminals • for auxiliary and control contacts with screw-type terminals 	18 ... 22 lbf·in 4.5 ... 5.3 lbf·in
design of the thread of the connection screw	
<ul style="list-style-type: none"> • for main contacts • of the auxiliary and control contacts 	M4 M3
stripped length of the cable	
<ul style="list-style-type: none"> • for main contacts • for auxiliary and control contacts 	10 mm 7 mm
Electrical Safety	
protection class IP on the front according to IEC 60529	IP20
touch protection on the front according to IEC 60529	finger-safe, for vertical contact from the front
Ambient conditions	
installation altitude at height above sea level maximum	1 000 m
ambient temperature	
<ul style="list-style-type: none"> • during operation • during storage 	-25 ... +60 °C -55 ... +80 °C
Electromagnetic compatibility	
conducted interference	
<ul style="list-style-type: none"> • due to burst according to IEC 61000-4-4 • due to conductor-earth surge according to IEC 61000-4-5 • due to conductor-conductor surge according to IEC 61000-4-5 • due to high-frequency radiation according to IEC 61000-4-6 	2 kV / 5 kHz behavior criterion 2 2 kV behavior criterion 2 1 kV behavior criterion 2 140 dBuV in the frequency range 0.15 ... 80 MHz, behavior criterion 1
field-based interference according to IEC 61000-4-3	80 MHz ... 1 GHz 10 V/m, behavior criterion 1
electrostatic discharge according to IEC 61000-4-2	4 kV contact discharging / 8 kV air discharging, behavior criterion 2
conducted HF interference emissions according to CISPR11	Class A for industrial environment
field-bound HF interference emission according to CISPR11	Class B for the domestic, business and commercial environments
Short-circuit protection, design of the fuse link	
manufacturer's article number <ul style="list-style-type: none"> • of gS fuse for semiconductor protection at NH design usable • of full range R fuse link for semiconductor protection at cylindrical design usable • of back-up R fuse link for semiconductor protection at NH design usable • of back-up R fuse link for semiconductor protection at cylindrical design 10 x 38 mm usable • of back-up R fuse link for semiconductor protection at cylindrical design 14 x 51 mm usable • of back-up R fuse link for semiconductor protection at cylindrical design 22 x 58 mm usable 	3NE1803-0 5SE1335 3NE8003-1 3NC1032 3NC1450 3NC2263
manufacturer's article number of the gG fuse <ul style="list-style-type: none"> • at NH design usable • at cylindrical design 14 x 51 mm usable • at cylindrical design 22 x 58 mm usable 	3NA6807: These fuses have a smaller rated current than the semiconductor relays 3NW6105-1: These fuses have a smaller rated current than the semiconductor relays 3NW6205-1: These fuses have a smaller rated current than the semiconductor relays
manufacturer's article number <ul style="list-style-type: none"> • of DIAZED fuse usable 	5SB2711

- of NEOZED fuse usable

[5SE2320: These fuses have a smaller rated current than the semiconductor relays](#)

Approvals Certificates

General Product Approval		EMV	Test Certificates	
 EG-Konf.				 RCM
Type Test Certificates/Test Report				
Test Certificates	other	Railway	Environment	
Special Test Certificate		Confirmation	 VDE	Special Test Certificate
			Environmental Confirmations	

Further information

Information on the packaging

<https://support.industry.siemens.com/cs/ww/en/view/109813875>

Information for data generation and storage

<https://support.industry.siemens.com/cs/ww/en/view/109995012>

Information- and Downloadcenter (Catalogs, Brochures,...)

<https://www.siemens.com/ic10>

Industry Mall (Online ordering system)

<https://mall.industry.siemens.com/mall/en/en/Catalog/product?mlfb=3RF2330-1AA45>

Cax online generator

<https://support.automation.siemens.com/WW/CAXorder/default.aspx?lang=en&mlfb=3RF2330-1AA45>

Service&Support (Manuals, Certificates, Characteristics, FAQs,...)

<https://support.industry.siemens.com/cs/ww/en/ps/3RF2330-1AA45>

Image database (product images, 2D dimension drawings, 3D models, device circuit diagrams, EPLAN macros, ...)

https://www.automation.siemens.com/bilddb/cax_de.aspx?mlfb=3RF2330-1AA45&lang=en

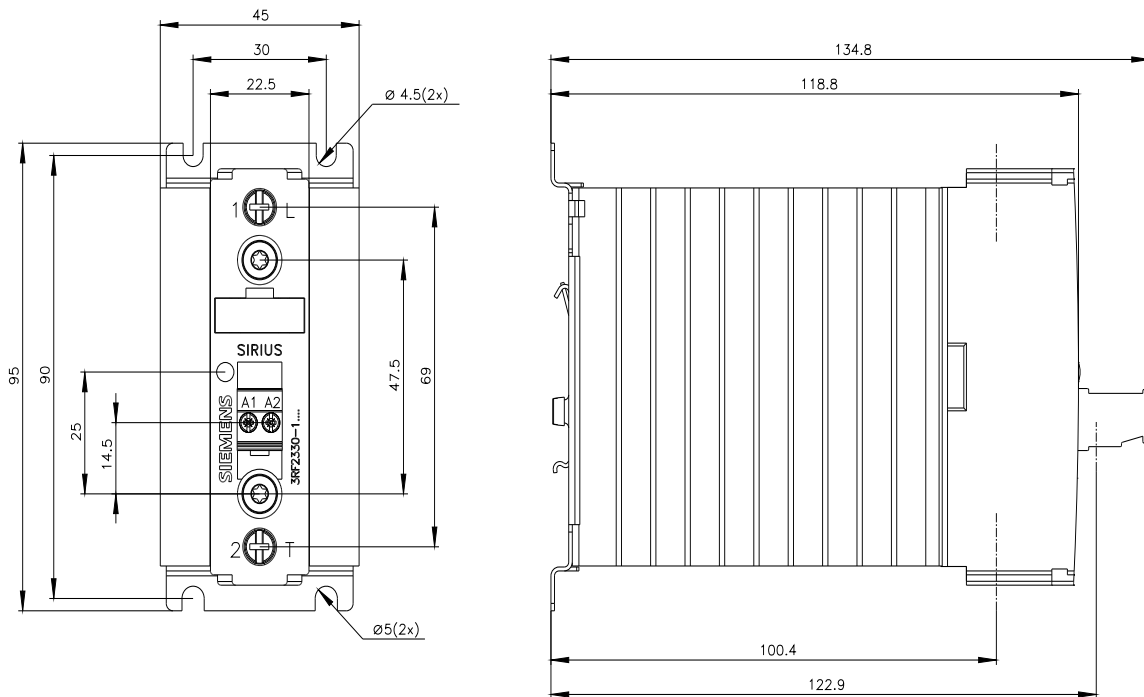

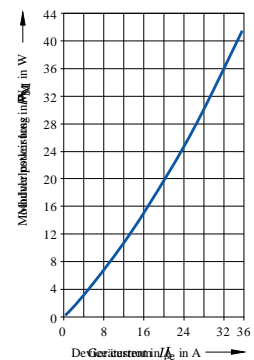
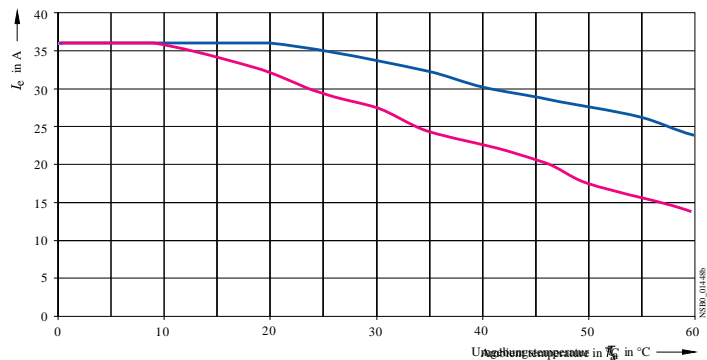
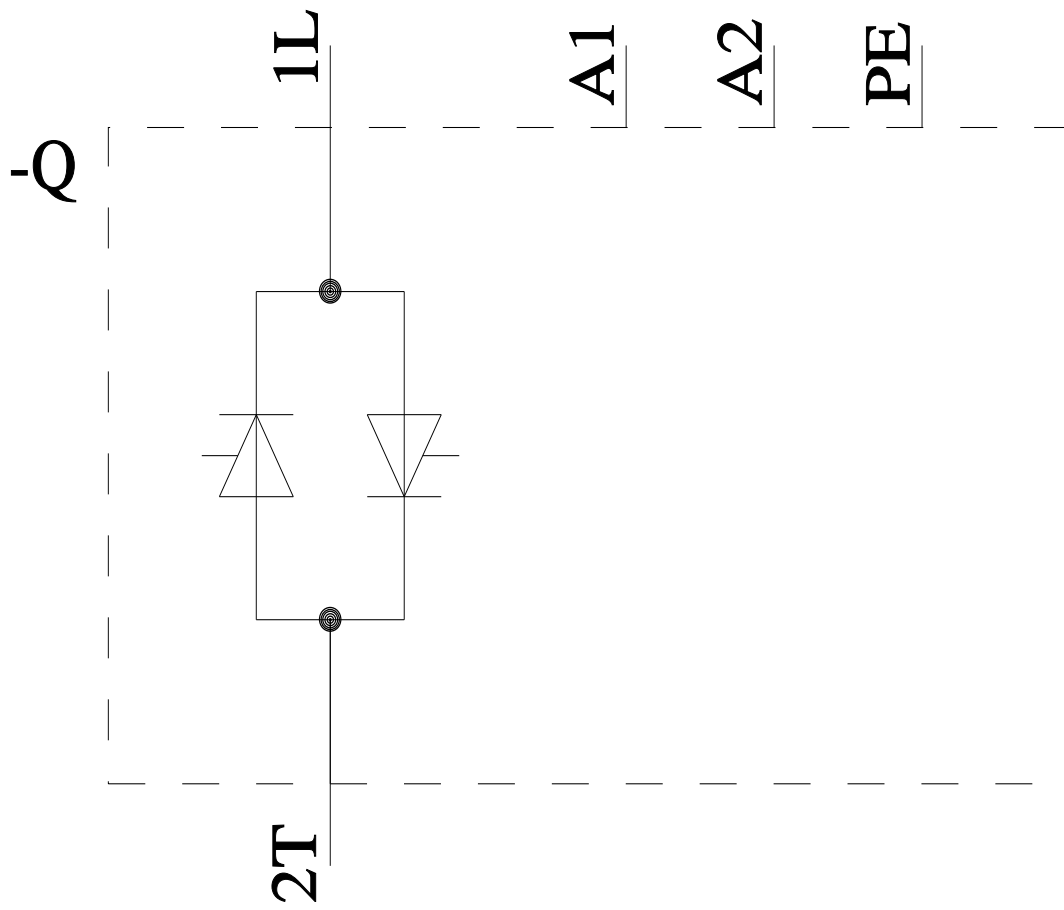

— I_{max} Thermal limit current for side-by-side mounting
— I_{IEC} Current according to IEC 947-4-3 for side-by-side mounting

last modified:

8/3/2025