







Solid-state contactor 3-phase 3RF2 AC 51 / 10 A / 40 °C 48-600 V / 110 V AC 3-phase controlled screw terminal Blocking voltage 1200 V

| | |
|--|--|
| product brand name | SIRIUS |
| product designation | solid-state contactor |
| design of the product | 3-pole controlled |
| product type designation | 3RF24 |
| General technical data | |
| product function | zero-point switching |
| power loss [W] for rated value of the current | |
| • at AC in hot operating state | 31 W |
| • at AC in hot operating state per pole | 10.33 W |
| • without load current share typical | 1.9 W |
| insulation voltage rated value | 600 V |
| degree of pollution | 3 |
| surge voltage resistance of main circuit rated value | 6 kV |
| protection class IP | IP20 |
| protection class IP on the front according to IEC 60529 | IP20 |
| shock resistance according to IEC 60068-2-27 | 15g / 11 ms |
| vibration resistance according to IEC 60068-2-6 | 2g |
| reference code according to IEC 81346-2 | Q |
| Substance Prohibition (Date) | 07/01/2006 |
| SVHC substance name | Lead - 7439-92-1 Lead monoxide (lead oxide) - 1317-36-8 Dibutylbis(pentane-2,4-dionato-O,O')tin - 22673-19-4 |
| Weight | 0.3 kg |
| Main circuit | |
| number of poles for main current circuit | 3 |
| number of NO contacts for main contacts | 3 |
| number of NC contacts for main contacts | 0 |
| type of voltage of the operating voltage | AC |
| operating voltage | |
| • at AC | |
| — at 50 Hz rated value | 48 ... 600 V |
| — at 60 Hz rated value | 48 ... 600 V |
| operating frequency rated value | 50 ... 60 Hz |
| relative symmetrical tolerance of the operating frequency | 10 % |
| operating range relative to the operating voltage at AC | |
| • at 50 Hz | 40 ... 660 V |
| • at 60 Hz | 40 ... 660 V |
| operational current | |
| • at AC-51 rated value | 10.5 A |
| • at AC-51 according to IEC 60947-4-3 | 7 A |
| • according to UL 508 rated value | 7 A |

| | |
|--|--|
| operational current minimum | 500 mA |
| rate of voltage rise at the thyristor for main contacts maximum permissible | 500 V/ μ s |
| blocking voltage at the thyristor for main contacts maximum permissible | 1 200 V |
| reverse current of the thyristor | 10 mA |
| derating temperature | 40 °C |
| surge current resistance rated value | 300 A |
| I²t value maximum | 450 A ² ·s |
| Control circuit/ Control | |
| type of voltage of the control supply voltage | AC |
| control supply voltage 1 at AC | |
| • at 50 Hz | 90 ... 125 V |
| • at 60 Hz | 90 ... 125 V |
| control supply voltage frequency | |
| • 1 rated value | 45 Hz |
| • 2 rated value | 66 Hz |
| control supply voltage at AC | |
| • at 50 Hz full-scale value for signal<0> recognition | 40 V |
| • at 60 Hz full-scale value for signal<0> recognition | 90 V |
| control supply voltage | |
| • at AC initial value for signal <1> detection | 90 V |
| symmetrical line frequency tolerance | 5 Hz |
| control current at minimum control supply voltage | |
| • at AC | 2 mA |
| control current at AC rated value | 15 mA |
| ON-delay time | 40 ms; additionally max. one half-wave |
| Auxiliary circuit | |
| type of switching contact | normally open contact (NO) |
| number of NC contacts for auxiliary contacts | 0 |
| number of NO contacts for auxiliary contacts | 0 |
| number of CO contacts for auxiliary contacts | 0 |
| Installation/ mounting/ dimensions | |
| fastening method side-by-side mounting | Yes |
| fastening method | screw fixing and snap-on mounting on standard mounting rail 35 mm according to IEC 60715 |
| design of the thread of the screw for securing the equipment | M4 |
| height | 95 mm |
| width | 45 mm |
| depth | 96.5 mm |
| Connections/ Terminals | |
| product component removable terminal for auxiliary and control circuit | Yes |
| type of electrical connection | |
| • for main current circuit | screw-type terminals |
| • for auxiliary and control circuit | screw-type terminals |
| type of connectable conductor cross-sections | |
| • for main contacts | |
| — solid | 2x (1.5 ... 2.5 mm ²), 2x (2.5 ... 6 mm ²) |
| — finely stranded with core end processing | 2x (1 ... 2.5 mm ²), 2x (2.5 ... 6 mm ²), 1x 10 mm ² |
| • for AWG cables for main contacts | 2x (14 ... 10) |
| connectable conductor cross-section for main contacts | |
| • solid or stranded | 1.5 ... 6 mm ² |
| • finely stranded with core end processing | 1 ... 10 mm ² |
| type of connectable conductor cross-sections | |
| • for auxiliary and control contacts | |
| — solid | 1x (0.5 ... 2.5 mm ²), 2x (0.5 ... 1 mm ²) |
| — finely stranded with core end processing | 1x (0.5 ... 2.5 mm ²), 2x (0.5 ... 1 mm ²) |
| — finely stranded without core end processing | 1x (0.5 ... 2.5 mm ²), 2x (0.5 ... 1 mm ²) |
| • for AWG cables for auxiliary and control contacts | 1x (20 ... 12) |
| AWG number as coded connectable conductor cross | 14 ... 10 |

| | | |
|--|---|---|
| section for main contacts | | |
| tightening torque | | |
| <ul style="list-style-type: none"> • for main contacts with screw-type terminals • for auxiliary and control contacts with screw-type terminals | <p>2 ... 2.5 N·m</p> <p>0.5 ... 0.6 N·m</p> | |
| tightening torque [lbf·in] | | |
| <ul style="list-style-type: none"> • for main contacts with screw-type terminals • for auxiliary and control contacts with screw-type terminals | <p>18 ... 22 lbf·in</p> <p>7.5 ... 5.3 lbf·in</p> | |
| design of the thread of the connection screw | | |
| <ul style="list-style-type: none"> • for main contacts • of the auxiliary and control contacts | <p>M4</p> <p>M3</p> | |
| stripped length of the cable | | |
| <ul style="list-style-type: none"> • for main contacts • for auxiliary and control contacts | <p>10 mm</p> <p>7 mm</p> | |
| Electrical Safety | | |
| protection class IP on the front according to IEC 60529 | IP20 | |
| touch protection on the front according to IEC 60529 | finger-safe, for vertical contact from the front | |
| Ambient conditions | | |
| installation altitude at height above sea level maximum | 1 000 m | |
| ambient temperature | | |
| <ul style="list-style-type: none"> • during operation • during storage | <p>-25 ... +60 °C</p> <p>-55 ... +80 °C</p> | |
| Electromagnetic compatibility | | |
| conducted interference | | |
| <ul style="list-style-type: none"> • due to burst according to IEC 61000-4-4 • due to conductor-earth surge according to IEC 61000-4-5 • due to conductor-conductor surge according to IEC 61000-4-5 • due to high-frequency radiation according to IEC 61000-4-6 | <p>2 kV / 5 kHz behavior criterion 2</p> <p>2 kV behavior criterion 2</p> <p>1 kV behavior criterion 2</p> <p>140 dBuV in the frequency range 0.15 ... 80 MHz, behavior criterion 1</p> | |
| electrostatic discharge according to IEC 61000-4-2 | 4 kV contact discharging / 8 kV air discharging, behavior criterion 2 | |
| conducted HF interference emissions according to CISPR11 | Class A for industrial environment | |
| field-bound HF interference emission according to CISPR11 | Class A for industrial environment | |
| Short-circuit protection, design of the fuse link | | |
| <p>manufacturer's article number</p> <ul style="list-style-type: none"> • of full range R fuse link for semiconductor protection at NH design usable • of full range R fuse link for semiconductor protection at cylindrical design usable • of back-up R fuse link for semiconductor protection at NH design usable • of back-up R fuse link for semiconductor protection at cylindrical design 10 x 38 mm usable • of back-up R fuse link for semiconductor protection at cylindrical design 14 x 51 mm usable • of back-up R fuse link for semiconductor protection at cylindrical design 22 x 58 mm usable | <p>3NE1813-0</p> <p>5SE1310: Maximum operating voltage 400 V!</p> <p>3NE8015-1</p> <p>3NC1016</p> <p>3NC1420</p> <p>3NC2220</p> | |
| <p>manufacturer's article number of the gG fuse at NH design usable</p> <ul style="list-style-type: none"> • up to 460 V | <p>3NA3801: These fuses have a smaller rated current than the semiconductor relays</p> | |
| Approvals Certificates | | |
| General Product Approval | EMV | Test Certificates |
|  |  |  |
|  |  | Type Test Certificates/Test Report |
| other | Environment | |



[Confirmation](#)



[Environmental Confirmations](#)

Further information

Information on the packaging

<https://support.industry.siemens.com/cs/ww/en/view/109813875>

Information for data generation and storage

<https://support.industry.siemens.com/cs/ww/en/view/109995012>

Information- and Downloadcenter (Catalogs, Brochures,...)

<https://www.siemens.com/ic10>

Industry Mall (Online ordering system)

<https://mall.industry.siemens.com/mall/en/en/Catalog/product?mlfb=3RF2410-1AC35>

Cax online generator

<https://support.automation.siemens.com/WW/CAXorder/default.aspx?lang=en&mlfb=3RF2410-1AC35>

Service&Support (Manuals, Certificates, Characteristics, FAQs,...)

<https://support.industry.siemens.com/cs/ww/en/ps/3RF2410-1AC35>

Image database (product images, 2D dimension drawings, 3D models, device circuit diagrams, EPLAN macros, ...)

https://www.automation.siemens.com/bilddb/cax_de.aspx?mlfb=3RF2410-1AC35&lang=en

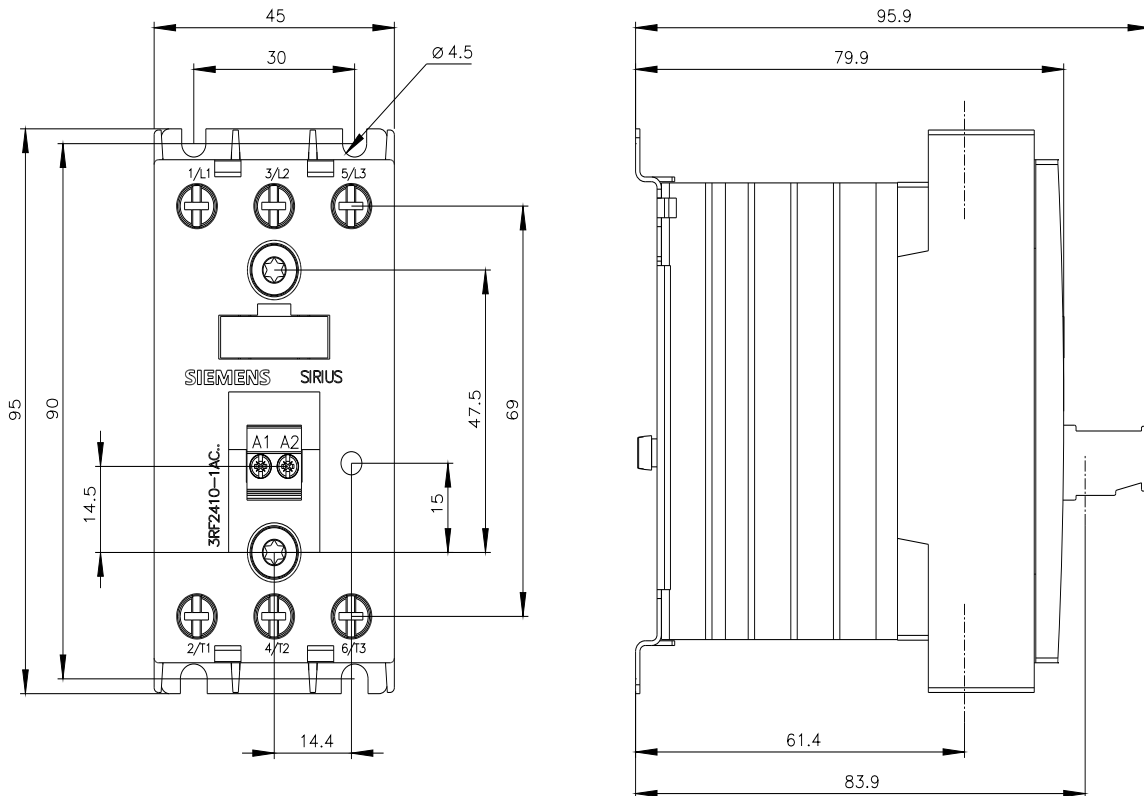

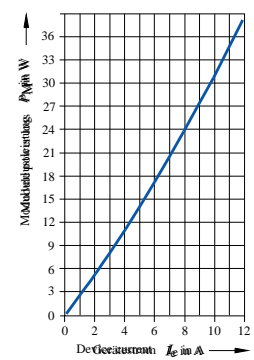
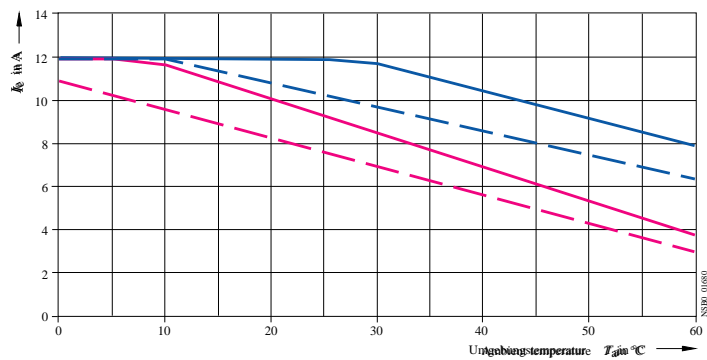

- I_{\max} Thermischer Grenzstrom bei Einzelaufstellung
- - - I_{\max} Thermischer Grenzstrom bei Dicht-an-Dicht-Montage
- I_{IEC} Strom nach IEC 947-4-3 bei Einzelaufstellung
- - - I_{IEC} Strom nach IEC 947-4-3 bei Dicht-an-Dicht-Montage

last modified:

8/4/2025