







solid-state contactor 3-phase 3RF2 AC 51 / 22 A / 40 °C 48-600 V / 4-30 V DC 2-phase controlled screw terminal blocking voltage 1200 V

<b>product brand name</b>	SIRIUS
<b>product designation</b>	solid-state contactor
<b>design of the product</b>	2-pole controlled
<b>product type designation</b>	3RF24
<b>manufacturer's article number</b>	
<ul style="list-style-type: none"> <li>_2 of the accessories that can be ordered</li> </ul>	<a href="#">3RF2900-0EA18</a>
<b>product designation</b>	
<ul style="list-style-type: none"> <li>_2 of the accessories that can be ordered</li> </ul>	converter
<b>General technical data</b>	
<b>product function</b>	zero-point switching
<b>power loss [W] for rated value of the current</b>	
<ul style="list-style-type: none"> <li>at AC in hot operating state</li> </ul>	44 W
<ul style="list-style-type: none"> <li>at AC in hot operating state per pole</li> </ul>	14.67 W
<ul style="list-style-type: none"> <li>without load current share typical</li> </ul>	0.9 W
<b>insulation voltage rated value</b>	600 V
<b>degree of pollution</b>	3
surge voltage resistance of main circuit rated value	6 kV
<b>protection class IP</b>	IP20
protection class IP on the front according to IEC 60529	IP20
<b>shock resistance according to IEC 60068-2-27</b>	15g / 11 ms
<b>vibration resistance according to IEC 60068-2-6</b>	2g
<b>reference code according to IEC 81346-2</b>	Q
<b>Substance Prohibitance (Date)</b>	07/01/2006
<b>SVHC substance name</b>	Lead - 7439-92-1 Lead monoxide (lead oxide) - 1317-36-8 Dibutylbis(pentane-2,4-dionato-O,O')tin - 22673-19-4
<b>Weight</b>	0.338 kg
<b>Main circuit</b>	
<b>number of poles for main current circuit</b>	3
<b>number of NO contacts for main contacts</b>	2
<b>number of NC contacts for main contacts</b>	0
<b>type of voltage of the operating voltage</b>	AC
<b>operating voltage</b>	
<ul style="list-style-type: none"> <li>at AC <ul style="list-style-type: none"> <li>at 50 Hz rated value</li> </ul> </li> </ul>	48 ... 600 V
<ul style="list-style-type: none"> <li>at AC <ul style="list-style-type: none"> <li>at 60 Hz rated value</li> </ul> </li> </ul>	48 ... 600 V
<b>operating frequency rated value</b>	50 ... 60 Hz
<b>relative symmetrical tolerance of the operating frequency</b>	10 %
<b>operating range relative to the operating voltage at AC</b>	
<ul style="list-style-type: none"> <li>at 50 Hz</li> </ul>	40 ... 660 V
<ul style="list-style-type: none"> <li>at 60 Hz</li> </ul>	40 ... 660 V

<b>operational current</b>	
<ul style="list-style-type: none"> <li>• at AC-51 rated value</li> <li>• at AC-51 according to IEC 60947-4-3</li> <li>• according to UL 508 rated value</li> </ul>	<p>22 A</p> <p>15 A</p> <p>15 A</p>
<b>operational current minimum</b>	500 mA
<b>rate of voltage rise at the thyristor for main contacts maximum permissible</b>	1 000 V/μs
<b>blocking voltage at the thyristor for main contacts maximum permissible</b>	1 200 V
<b>reverse current of the thyristor</b>	10 mA
<b>derating temperature</b>	40 °C
<b>surge current resistance rated value</b>	600 A
<b>I<sup>2</sup>t value maximum</b>	1 800 A <sup>2</sup> ·s
<b>Control circuit/ Control</b>	
<b>type of voltage of the control supply voltage</b>	DC
<b>control supply voltage 1 at DC rated value maximum permissible</b>	30 V
<b>control supply voltage 1 at DC</b>	4 ... 30 V
<b>control supply voltage</b>	
<ul style="list-style-type: none"> <li>• at DC initial value for signal &lt;1&gt; detection</li> <li>• at DC full-scale value for signal &lt;0&gt; recognition</li> </ul>	<p>4 V</p> <p>1 V</p>
<b>symmetrical line frequency tolerance</b>	5 Hz
<b>control current at minimum control supply voltage</b>	
<ul style="list-style-type: none"> <li>• at DC</li> </ul>	22 mA
control current at DC rated value	30 mA
<b>ON-delay time</b>	1 ms; additionally max. one half-wave
<b>Auxiliary circuit</b>	
<b>type of switching contact</b>	normally open contact (NO)
<b>number of NC contacts for auxiliary contacts</b>	0
<b>number of NO contacts for auxiliary contacts</b>	0
number of CO contacts for auxiliary contacts	0
<b>Installation/ mounting/ dimensions</b>	
fastening method side-by-side mounting	Yes
<b>fastening method</b>	screw fixing and snap-on mounting on standard mounting rail 35 mm according to IEC 60715
<b>design of the thread of the screw for securing the equipment</b>	M4
<b>height</b>	100 mm
<b>width</b>	45 mm
<b>depth</b>	117 mm
<b>Connections/ Terminals</b>	
<b>product component removable terminal for auxiliary and control circuit</b>	Yes
<b>type of electrical connection</b>	
<ul style="list-style-type: none"> <li>• for main current circuit</li> <li>• for auxiliary and control circuit</li> </ul>	<p>screw-type terminals</p> <p>screw-type terminals</p>
<b>type of connectable conductor cross-sections</b>	
<ul style="list-style-type: none"> <li>• for main contacts <ul style="list-style-type: none"> <li>— solid</li> <li>— finely stranded with core end processing</li> </ul> </li> <li>• for AWG cables for main contacts</li> </ul>	<p>2x (1.5 ... 2.5 mm<sup>2</sup>), 2x (2.5 ... 6 mm<sup>2</sup>)</p> <p>2x (1 ... 2.5 mm<sup>2</sup>), 2x (2.5 ... 6 mm<sup>2</sup>), 1x 10 mm<sup>2</sup></p> <p>2x (14 ... 10)</p>
<b>connectable conductor cross-section for main contacts</b>	
<ul style="list-style-type: none"> <li>• solid or stranded</li> <li>• finely stranded with core end processing</li> <li>• finely stranded without core end processing</li> </ul>	<p>0.5 ... 2.5 mm<sup>2</sup></p> <p>0.5 ... 1.5 mm<sup>2</sup></p> <p>0.5 ... 2.5 mm<sup>2</sup></p>
<b>type of connectable conductor cross-sections</b>	
<ul style="list-style-type: none"> <li>• for auxiliary and control contacts <ul style="list-style-type: none"> <li>— solid</li> <li>— finely stranded with core end processing</li> <li>— finely stranded without core end processing</li> </ul> </li> <li>• for AWG cables for auxiliary and control contacts</li> </ul>	<p>1x (0.5 ... 2.5 mm<sup>2</sup>), 2x (0.5 ... 1 mm<sup>2</sup>)</p> <p>1x (0.5 ... 2.5 mm<sup>2</sup>), 2x (0.5 ... 1 mm<sup>2</sup>)</p> <p>1x (0.5 ... 2.5 mm<sup>2</sup>), 2x (0.5 ... 1 mm<sup>2</sup>)</p> <p>1x (20 ... 12)</p>
<b>AWG number as coded connectable conductor cross section for main contacts</b>	14 ... 10

<b>tightening torque</b>	<ul style="list-style-type: none"> <li>• for main contacts with screw-type terminals</li> <li>• for auxiliary and control contacts with screw-type terminals</li> </ul>	2 ... 2.5 N·m 0.5 ... 0.6 N·m
<b>tightening torque [lbf·in]</b>	<ul style="list-style-type: none"> <li>• for main contacts with screw-type terminals</li> <li>• for auxiliary and control contacts with screw-type terminals</li> </ul>	18 ... 22 lbf·in 7.5 ... 5.3 lbf·in
<b>design of the thread of the connection screw</b>	<ul style="list-style-type: none"> <li>• for main contacts</li> <li>• of the auxiliary and control contacts</li> </ul>	M4 M3
<b>stripped length of the cable</b>	<ul style="list-style-type: none"> <li>• for main contacts</li> <li>• for auxiliary and control contacts</li> </ul>	10 mm 7 mm
<b>Electrical Safety</b>		
<b>protection class IP on the front according to IEC 60529</b>		IP20
<b>touch protection on the front according to IEC 60529</b>		finger-safe, for vertical contact from the front
<b>Ambient conditions</b>		
installation altitude at height above sea level maximum		1 000 m
<b>ambient temperature</b>	<ul style="list-style-type: none"> <li>• during operation</li> <li>• during storage</li> </ul>	-25 ... +60 °C -55 ... +80 °C
<b>Electromagnetic compatibility</b>		
<b>conducted interference</b>	<ul style="list-style-type: none"> <li>• due to burst according to IEC 61000-4-4</li> <li>• due to conductor-earth surge according to IEC 61000-4-5</li> <li>• due to conductor-conductor surge according to IEC 61000-4-5</li> <li>• due to high-frequency radiation according to IEC 61000-4-6</li> </ul>	2 kV / 5 kHz behavior criterion 2 2 kV behavior criterion 2 1 kV behavior criterion 2 140 dBuV in the frequency range 0.15 ... 80 MHz, behavior criterion 1
<b>electrostatic discharge according to IEC 61000-4-2</b>		4 kV contact discharging / 8 kV air discharging, behavior criterion 2
<b>conducted HF interference emissions according to CISPR11</b>		Class A for industrial environment
<b>field-bound HF interference emission according to CISPR11</b>		Class A for industrial environment
<b>Short-circuit protection, design of the fuse link</b>		
manufacturer's article number	<ul style="list-style-type: none"> <li>• of full range R fuse link for semiconductor protection at NH design usable</li> <li>• of full range R fuse link for semiconductor protection at cylindrical design usable</li> <li>• of back-up R fuse link for semiconductor protection at NH design usable</li> <li>• of back-up R fuse link for semiconductor protection at cylindrical design 10 x 38 mm usable</li> <li>• of back-up R fuse link for semiconductor protection at cylindrical design 14 x 51 mm usable</li> <li>• of back-up R fuse link for semiconductor protection at cylindrical design 22 x 58 mm usable</li> </ul>	<a href="#">3NE1814-0</a> <a href="#">5SE1320: Maximum operating voltage 400 V!</a> <a href="#">3NE8015-1</a> <a href="#">3NC1032</a> <a href="#">3NC1450</a> <a href="#">3NC2250</a>
manufacturer's article number of the gG fuse at NH design usable	<ul style="list-style-type: none"> <li>• up to 460 V</li> </ul>	<a href="#">3NA3805: These fuses have a smaller rated current than the semiconductor relays</a>
<b>Approvals Certificates</b>		
<b>General Product Approval</b>	<b>EMV</b>	<b>Test Certificates</b>
 EG-Konf.		 UL
	 RCM	<a href="#">Type Test Certificates/Test Report</a>
<b>other</b>	<b>Environment</b>	



Confirmation



Environmental Con-  
firmations

Further information

Information on the packaging

<https://support.industry.siemens.com/cs/ww/en/view/109813875>

Information for data generation and storage

<https://support.industry.siemens.com/cs/ww/en/view/109995012>

Information- and Downloadcenter (Catalogs, Brochures,...)

<https://www.siemens.com/ic10>

Industry Mall (Online ordering system)

<https://mall.industry.siemens.com/mall/en/en/Catalog/product?mlfb=3RF2420-1AB45>

Cax online generator

<https://support.automation.siemens.com/WW/CAXorder/default.aspx?lang=en&mlfb=3RF2420-1AB45>

Service&Support (Manuals, Certificates, Characteristics, FAQs,...)

<https://support.industry.siemens.com/cs/ww/en/ps/3RF2420-1AB45>

Image database (product images, 2D dimension drawings, 3D models, device circuit diagrams, EPLAN macros, ...)

[https://www.automation.siemens.com/bilddb/cax\\_de.aspx?mlfb=3RF2420-1AB45&lang=en](https://www.automation.siemens.com/bilddb/cax_de.aspx?mlfb=3RF2420-1AB45&lang=en)

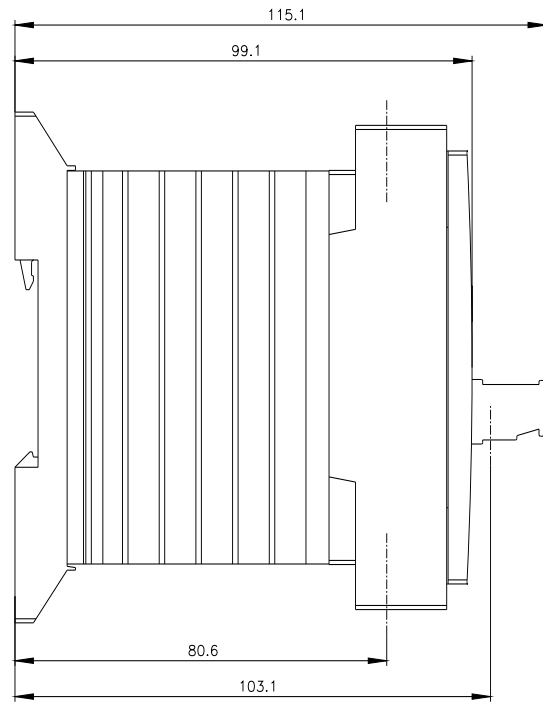
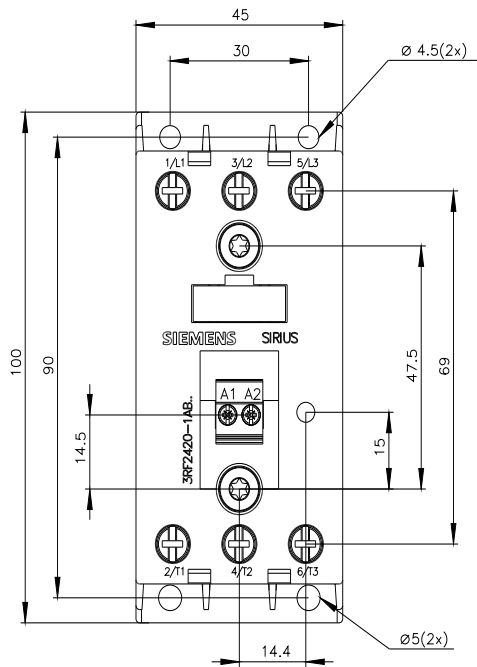

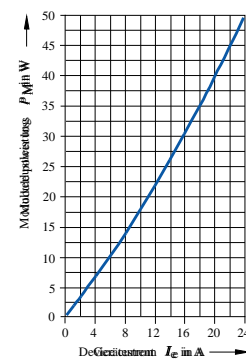
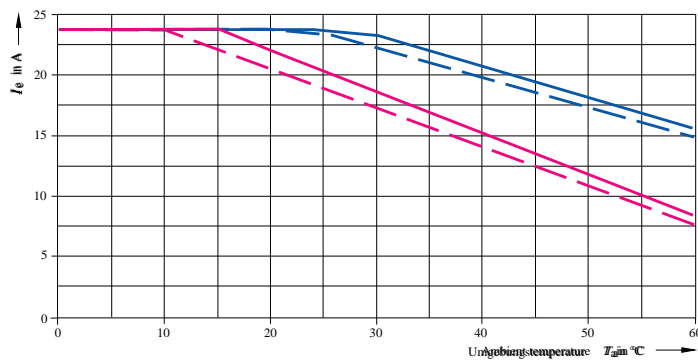
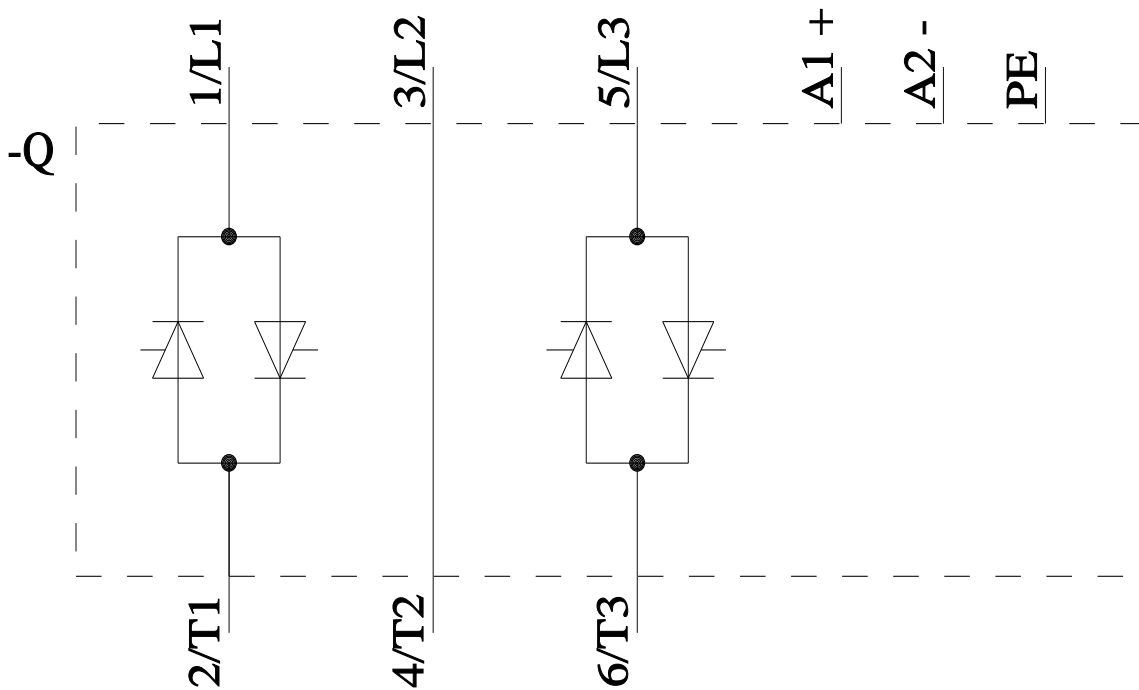

- $I_{\max}$  Thermischer Grenzstrom bei Einzelaufstellung
- - -  $I_{\max}$  Thermischer Grenzstrom bei Dicht-an-Dicht-Montage
- $I_{\text{IEC}}$  Strom nach IEC 947-4-3 bei Einzelaufstellung
- - -  $I_{\text{IEC}}$  Strom nach IEC 947-4-3 bei Dicht-an-Dicht-Montage

last modified:

8/4/2025