



contactor relay railway, 2 NO + 2 NC, 72-125 V DC, 0.7-1.25*Us, with integrated varistor, screw terminal, frame size S00

| | |
|---|--|
| product brand name | SIRIUS |
| product designation | Contactor relay for railway applications |
| product type designation | 3RH2 |
| General technical data | |
| size of contactor | S00 |
| product extension auxiliary switch | Yes |
| power loss [W] for rated value of the current without load current share typical | 0.75 W |
| insulation voltage with degree of pollution 3 at AC rated value | 690 V |
| surge voltage resistance rated value | 6 kV |
| shock resistance at rectangular impulse | |
| • at DC | 10g / 5 ms, 5g / 10 ms |
| shock resistance with sine pulse | |
| • at DC | 15g / 5 ms, 8g / 10 ms |
| mechanical service life (operating cycles) | |
| • of contactor typical | 30 000 000 |
| • of the contactor with added electronically optimized auxiliary switch block typical | 5 000 000 |
| • of the contactor with added auxiliary switch block typical | 10 000 000 |
| reference code according to IEC 81346-2 | K |
| Substance Prohibittance (Date) | 10/01/2009 |
| SVHC substance name | Lead - 7439-92-1 Lead monoxide (lead oxide) - 1317-36-8 2,2',6,6'-tetrabromo-4,4'-isopropylidenediphenol - 79-94-7 |
| Weight | 0.29 kg |
| Ambient conditions | |
| installation altitude at height above sea level maximum | 2 000 m |
| ambient temperature | |
| • during operation | -40 ... +70 °C |
| • during storage | -55 ... +80 °C |
| relative humidity minimum | 10 % |
| relative humidity at 55 °C according to IEC 60068-2-30 maximum | 95 % |
| Environmental footprint | |
| Environmental Product Declaration (EPD) | Yes |
| global warming potential [CO2 eq] total | 133 kg |
| global warming potential [CO2 eq] during manufacturing | 1.3 kg |
| global warming potential [CO2 eq] during operation | 132 kg |
| global warming potential [CO2 eq] after end of life | -0.227 kg |
| Main circuit | |
| no-load switching frequency | |
| • at DC | 1 500 1/h |

| Control circuit/ Control | |
|---|--------------|
| type of voltage of the control supply voltage | DC |
| control supply voltage at DC rated value | 72 ... 125 V |
| operating range factor control supply voltage rated value of magnet coil at DC | |
| • initial value | 0.7 |
| • full-scale value | 1.25 |
| design of the surge suppressor | Varistor |
| inrush current peak | 1.1 A |
| duration of inrush current peak | 50 µs |
| locked-rotor current mean value | 0.04 A |
| locked-rotor current peak | 0.04 A |
| duration of locked-rotor current | 250 ms |
| holding current mean value | 7 mA |
| closing power of magnet coil at DC | 4.5 W |
| holding power of magnet coil at DC | 0.75 W |
| closing delay | |
| • at DC | 30 ... 70 ms |
| opening delay | |
| • at DC | 25 ... 45 ms |
| arcing time | 10 ... 15 ms |
| residual current of the electronics for control with signal <0> at DC at 24 V maximum permissible | 10 mA |
| Auxiliary circuit | |
| number of NC contacts for auxiliary contacts | 2 |
| • instantaneous contact | 2 |
| number of NO contacts for auxiliary contacts | 2 |
| • instantaneous contact | 2 |
| identification number and letter for switching elements | 22 E |
| operational current at AC-12 maximum | 10 A |
| operational current at AC-15 | |
| • at 230 V rated value | 10 A |
| • at 400 V rated value | 3 A |
| • at 500 V rated value | 2 A |
| • at 690 V rated value | 1 A |
| operational current at 1 current path at DC-12 | |
| • at 24 V rated value | 10 A |
| • at 110 V rated value | 3 A |
| • at 220 V rated value | 1 A |
| • at 440 V rated value | 0.3 A |
| • at 600 V rated value | 0.15 A |
| operational current with 2 current paths in series at DC-12 | |
| • at 24 V rated value | 10 A |
| • at 60 V rated value | 10 A |
| • at 110 V rated value | 4 A |
| • at 220 V rated value | 2 A |
| • at 440 V rated value | 1.3 A |
| • at 600 V rated value | 0.65 A |
| operational current with 3 current paths in series at DC-12 | |
| • at 24 V rated value | 10 A |
| • at 60 V rated value | 10 A |
| • at 110 V rated value | 10 A |
| • at 220 V rated value | 3.6 A |
| • at 440 V rated value | 2.5 A |
| • at 600 V rated value | 1.8 A |
| operating frequency at DC-12 maximum | 1 000 1/h |
| operational current at 1 current path at DC-13 | |
| • at 24 V rated value | 10 A |
| • at 110 V rated value | 1 A |
| • at 220 V rated value | 0.3 A |
| • at 440 V rated value | 0.14 A |



| | |
|---|---|
| <ul style="list-style-type: none"> at 600 V rated value | 0.1 A |
| operational current with 2 current paths in series at DC-13 | |
| <ul style="list-style-type: none"> at 24 V rated value at 60 V rated value at 110 V rated value at 220 V rated value at 440 V rated value at 600 V rated value | 10 A 3.5 A 1.3 A 0.9 A 0.2 A 0.1 A |
| operational current with 3 current paths in series at DC-13 | |
| <ul style="list-style-type: none"> at 24 V rated value at 60 V rated value at 110 V rated value at 220 V rated value at 440 V rated value at 600 V rated value | 10 A 4.7 A 3 A 1.2 A 0.5 A 0.26 A |
| operating frequency at DC-13 maximum | 1 000 1/h |
| contact reliability of auxiliary contacts | 1 faulty switching per 100 million (17 V, 1 mA) |
| UL/CSA ratings | |
| contact rating of auxiliary contacts according to UL | A600 / Q600 |
| Short-circuit protection | |
| design of the miniature circuit breaker for short-circuit protection of the auxiliary circuit up to 230 V | C characteristic: 10 A; 0.4 kA |
| design of the fuse link for short-circuit protection of the auxiliary switch required | gG: 10 A (690 V, 1 kA) |
| Installation/ mounting/ dimensions | |
| mounting position | +/-180° rotation possible on vertical mounting surface, can be tilted forward and backward by +/- 22.5° on vertical mounting surface, standing, on horizontal mounting surface |
| fastening method side-by-side mounting | Yes |
| fastening method | screw and snap-on mounting onto 35 mm DIN rail |
| height | 58 mm |
| width | 45 mm |
| depth | 73 mm |
| required spacing | |
| <ul style="list-style-type: none"> with side-by-side mounting <ul style="list-style-type: none"> forwards upwards downwards at the side for grounded parts <ul style="list-style-type: none"> forwards upwards at the side downwards for live parts <ul style="list-style-type: none"> forwards upwards downwards at the side | 10 mm 10 mm 10 mm 0 mm 10 mm 10 mm 6 mm 10 mm 10 mm 10 mm 10 mm 6 mm |
| Connections/ Terminals | |
| type of electrical connection for auxiliary and control circuit | screw-type terminals |
| connectable conductor cross-section for auxiliary contacts | |
| <ul style="list-style-type: none"> solid or stranded finely stranded with core end processing | 0.5 ... 4 mm ² 0.5 ... 2.5 mm ² |
| type of connectable conductor cross-sections | |
| <ul style="list-style-type: none"> for auxiliary contacts <ul style="list-style-type: none"> solid or stranded finely stranded with core end processing for AWG cables for auxiliary contacts | 2x (0.5 ... 1.5 mm ²), 2x (0.75 ... 2.5 mm ²), 2x 4 mm ² 2x (0.5 ... 1.5 mm ²), 2x (0.75 ... 2.5 mm ²) 2x (20 ... 16), 2x (18 ... 14), 2x 12 |
| AWG number as coded connectable conductor cross section for auxiliary contacts | 20 ... 12 |
| Safety related data | |



| | |
|---|--|
| product function positively driven operation according to IEC 60947-5-1 | Yes |
| proportion of dangerous failures | |
| • with low demand rate according to SN 31920 | 40 % |
| • with high demand rate according to SN 31920 | 73 % |
| B10 value with high demand rate according to SN 31920 | 1 000 000 |
| IEC 61508 | |
| T1 value | |
| • for proof test interval or service life according to IEC 61508 | 20 a |
| Electrical Safety | |
| protection class IP on the front according to IEC 60529 | IP20 |
| touch protection on the front according to IEC 60529 | finger-safe, for vertical contact from the front |
| Approvals Certificates | |
| General Product Approval | |



KC



| | | | |
|---|--|--|---|
| EMV | Functional Safety | Test Certificates | Maritime application |
|  | Type Examination Certificate | Special Test Certificate | Type Test Certificates/Test Report |
| RCM | | |  ABS  BUREAU VERITAS |

| | |
|--|--|
| Maritime application | other |
|  LRS  PRS  RMRS | Miscellaneous  产品合格 QC PASS Confirmation |

| | | |
|--|---------------------------------------|--|
| Railway | Dangerous goods | Environment |
| Special Test Certificate | Transport Information |  EPD Environmental Confirmations |

Further information

- Information on the packaging
<https://support.industry.siemens.com/cs/ww/en/view/109813875>
- Information for data generation and storage
<https://support.industry.siemens.com/cs/ww/en/view/109995012>
- Information- and Downloadcenter (Catalogs, Brochures,...)
<https://www.siemens.com/ic10>
- Industry Mall (Online ordering system)
<https://mall.industry.siemens.com/mall/en/en/Catalog/product?mlfb=3RH2122-1XF40-0LA2>
- Cax online generator
<https://support.automation.siemens.com/WW/CAXorder/default.aspx?lang=en&mlfb=3RH2122-1XF40-0LA2>
- Service&Support (Manuals, Certificates, Characteristics, FAQs,...)
<https://support.industry.siemens.com/cs/ww/en/ps/3RH2122-1XF40-0LA2>
- Image database (product images, 2D dimension drawings, 3D models, device circuit diagrams, EPLAN macros, ...)
https://www.automation.siemens.com/bilddb/cax_de.aspx?mlfb=3RH2122-1XF40-0LA2&lang=en
- Characteristic: Tripping characteristics, I_t, Let-through current
<https://support.industry.siemens.com/cs/ww/en/ps/3RH2122-1XF40-0LA2/char>
- Further characteristics (e.g. electrical endurance, switching frequency)
<https://www.automation.siemens.com/bilddb/index.aspx?view=Search&mlfb=3RH2122-1XF40-0LA2&objecttype=14&gridview=view1>





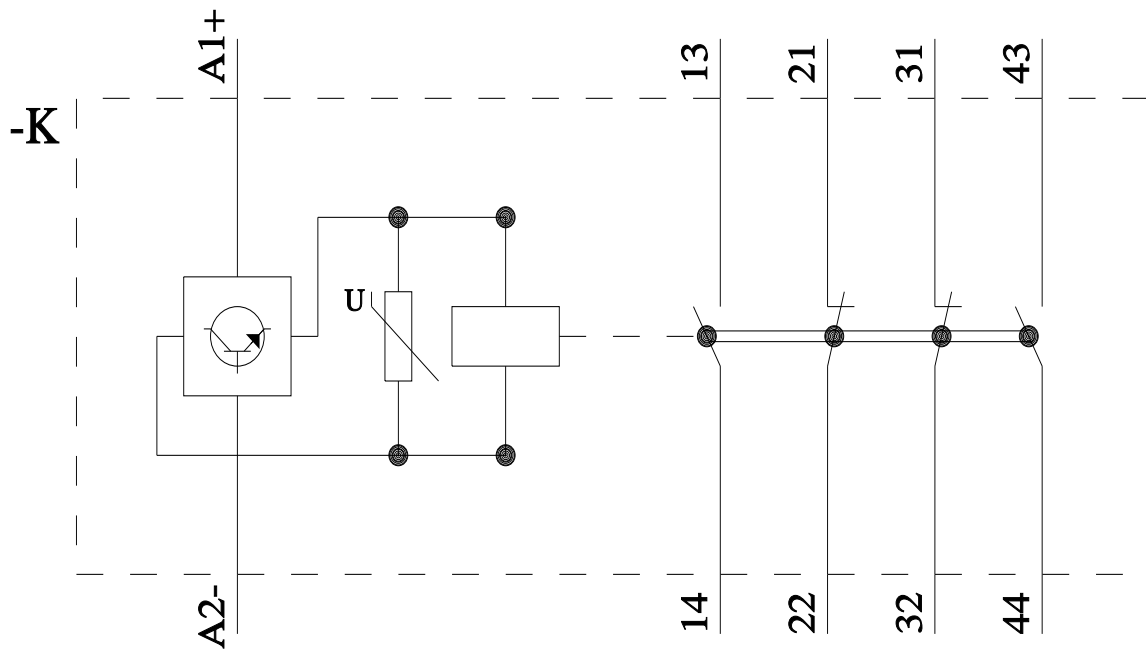

last modified:

9/5/2025 