



socket insert Han Q4/2 5 contact sockets 6 mm², 2 auxiliary contacts 0.5 mm² pin 11+12 connector set incoming power supply for connection to MS, isolator module of the ET 200pro, M200D, cable-end connector hood angled outgoing unit including screw connection

product brand name	SIRIUS
product designation	Power connector
connector type	Socket
type of cable outlet	angled
number of poles	6
protection class IP	IP65

Further information

Information on the packaging

<https://support.industry.siemens.com/cs/ww/en/view/109813875>

Information for data generation and storage

<https://support.industry.siemens.com/cs/ww/en/view/109995012>

Information- and Downloadcenter (Catalogs, Brochures,...)

<https://www.siemens.com/ic10>

Industry Mall (Online ordering system)

<https://mall.industry.siemens.com/mall/en/en/Catalog/product?mlfb=3RK1911-2BE30>

Cax online generator

<https://support.automation.siemens.com/WW/CAXorder/default.aspx?lang=en&mlfb=3RK1911-2BE30>

Service&Support (Manuals, Certificates, Characteristics, FAQs,...)

<https://support.industry.siemens.com/cs/ww/en/ps/3RK1911-2BE30>

Image database (product images, 2D dimension drawings, 3D models, device circuit diagrams, EPLAN macros, ...)

https://www.automation.siemens.com/bilddb/cax_de.aspx?mlfb=3RK1911-2BE30&lang=en

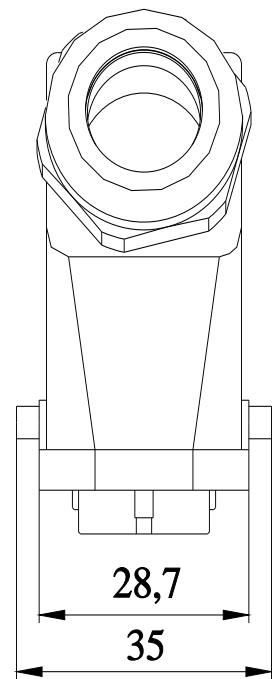
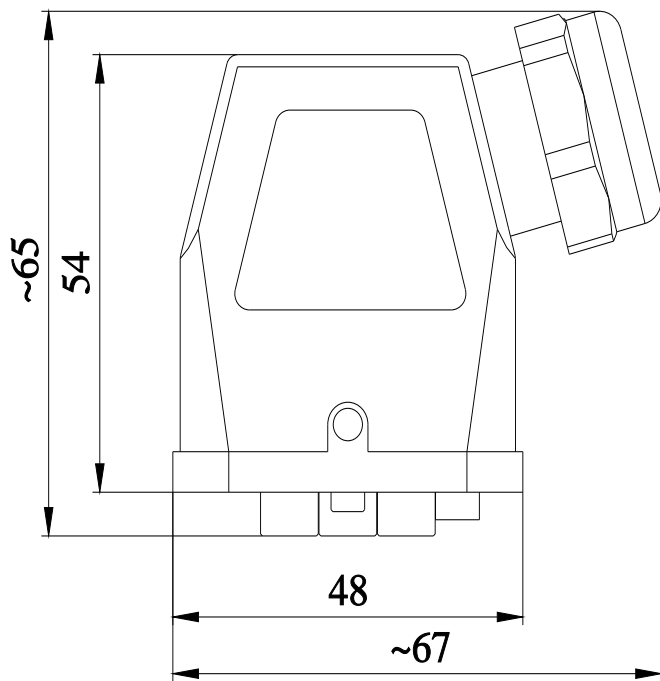

last modified:

4/1/2025 