











Changeover operating mechanism for 3RT1485, 3RT1486 and 3RT1487, AC (50...60 Hz) / DC operation, 100 ... 240 V AC / 100 ... 220 V DC

product brand name	SIRIUS
product category	Solenoid coils
product designation	Changeover operating mechanism
product type designation	3RT19
General technical data	
Substance Prohibance (Date)	03/27/2020
Weight	1.942 kg
type of voltage of the control supply voltage	AC/DC
control supply voltage 1 at AC	
• at 50 Hz rated value	100 V
• at 60 Hz rated value	100 V
control supply voltage 2 at AC	
• at 50 Hz rated value	240 V
• at 60 Hz rated value	240 V
control supply voltage 1 at DC rated value	100 V
control supply voltage 2 at DC rated value	220 V
operating range factor control supply voltage rated value of magnet coil at AC	
• at 50 Hz	0.85 ... 1.1
• at 60 Hz	0.85 ... 1.1
apparent pick-up power of magnet coil at AC	
• at 50 Hz	1 800 VA
• at 60 Hz	1 800 VA
apparent holding power of magnet coil at AC	
• at 50 Hz	33 VA
• at 60 Hz	33 VA

Approvals Certificates

General Product Approval	EMV	Test Certificates	Maritime application
     			
Maritime application	other	Railway	
 	Confirmation 	Miscellaneous	Special Test Certificate

[Environmental Con-
firmations](#)

Further information

Information on the packaging

<https://support.industry.siemens.com/cs/ww/en/view/109813875>

Information for data generation and storage

<https://support.industry.siemens.com/cs/ww/en/view/109995012>

Information- and Downloadcenter (Catalogs, Brochures,...)

<https://www.siemens.com/ic10>

Industry Mall (Online ordering system)

<https://mall.industry.siemens.com/mall/en/en/Catalog/product?mlfb=3RT1987-5AP31>

Cax online generator

<https://support.automation.siemens.com/WW/CAXorder/default.aspx?lang=en&mlfb=3RT1987-5AP31>

Service&Support (Manuals, Certificates, Characteristics, FAQs,...)

<https://support.industry.siemens.com/cs/ww/en/ps/3RT1987-5AP31>

Image database (product images, 2D dimension drawings, 3D models, device circuit diagrams, EPLAN macros, ...)

https://www.automation.siemens.com/bilddb/cax_de.aspx?mlfb=3RT1987-5AP31&lang=en

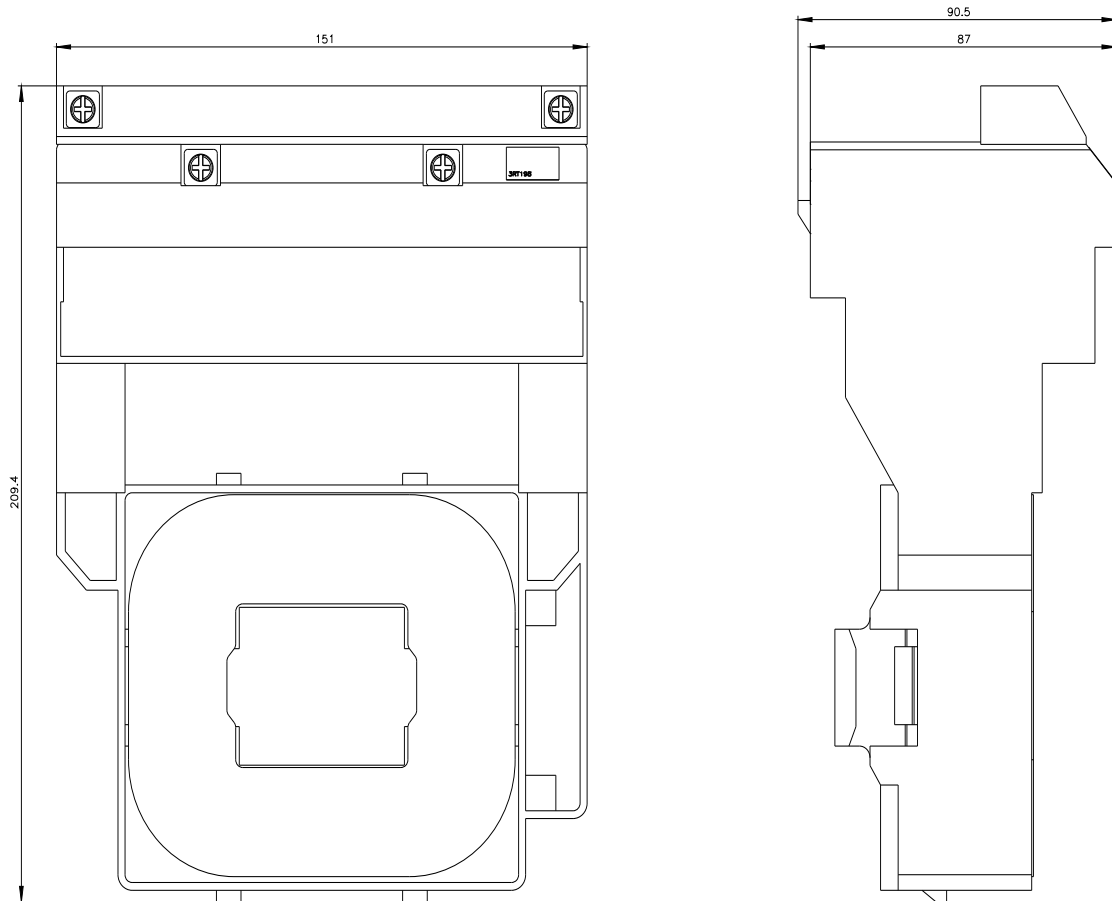

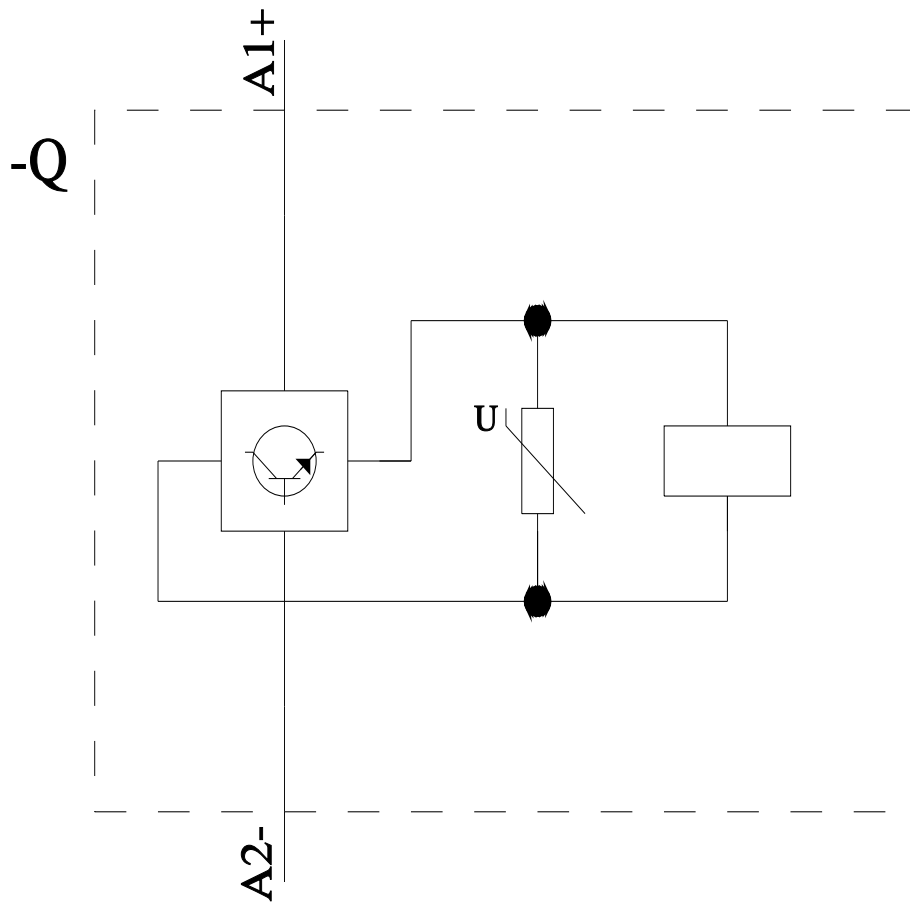

last modified:

4/2/2025 