











Siemens
EcoTech



Siemens keyswitch, B, 22 mm, round, metal, shiny, lock number S1, with 2 keys, 2 switch positions O<l, momentary contact type, actuating angle 45°, 10:30h/12h, key removal O



product brand name	SIRIUS ACT
product designation	Key-operated switches
design of the product	Actuating/signaling element
product type designation	3SU1
product line	Metal, shiny, 22 mm
manufacturer's article number of included key	3SU1950-0FD80-0AA0
Actuator	
principle of operation of the actuating element	momentary contact, 45° (10:30 h/12 h), return from center to left
product extension optional light source	No
color	
• of the actuating element	silver
material of the actuating element	metal
shape of the actuating element	Key
outer diameter of the actuating element	29.5 mm
number of switching positions	2
switch position for key distraction	O
actuating angle	
• clockwise	45°
lock make	Siemens, B
key number	S1
Front ring	
product component front ring	Yes
design of the front ring	Standard
material of the front ring	Metal, high gloss
color of the front ring	silver
General technical data	
protection class IP	IP66, IP67, IP69(IP69K)
protection class IP of the terminal	IP20
degree of protection NEMA rating	1, 2, 3, 3R, 4, 4X, 12, 13
shock resistance	
• according to IEC 60068-2-27	sinusoidal half-wave 15g / 11 ms
vibration resistance	
• according to IEC 60068-2-6	10 ... 500 Hz: 5g
operating frequency maximum	1 800 1/h
mechanical service life (operating cycles) typical	300 000
reference code according to IEC 81346-2	S

Substance Prohibittance (Date)	10/01/2014
Weight	153 g
Ambient conditions	
ambient temperature	
• during operation	-25 ... +70 °C
• during storage	-40 ... +80 °C
environmental category during operation according to IEC 60721	3M6, 3S2, 3B2, 3C3, 3K6 (with relative air humidity of 10 ... 95%)
Environmental footprint	
Environmental Product Declaration (EPD)	Yes
global warming potential [CO2 eq] total	0.593 kg
global warming potential [CO2 eq] during manufacturing	0.625 kg
global warming potential [CO2 eq] during operation	0.235 kg
global warming potential [CO2 eq] after end of life	-0.267 kg
Siemens Eco Profile (SEP)	Siemens EcoTech
Installation/ mounting/ dimensions	
height	29.5 mm
width	29.5 mm
shape of the installation opening	round
mounting diameter	22.3 mm
positive tolerance of installation diameter	0.4 mm
mounting height	56.3 mm
installation width	29.5 mm
installation depth	25.4 mm
Approvals Certificates	
General Product Approval	Test Certificates
   	Type Test Certificates/Test Report Special Test Certificate
Maritime application	other
   	 Confirmation
Environment	
 	Environmental Confirmations
Further information	
Information on the packaging https://support.industry.siemens.com/cs/ww/en/view/109813875	
Information for data generation and storage https://support.industry.siemens.com/cs/ww/en/view/109995012	
Information- and Downloadcenter (Catalogs, Brochures,...) https://www.siemens.com/ic10	
Industry Mall (Online ordering system) https://mall.industry.siemens.com/mall/en/en/Catalog/product?mlfb=3SU1050-5PC01-0AA0	
Cax online generator https://support.automation.siemens.com/WW/CAXorder/default.aspx?lang=en&mlfb=3SU1050-5PC01-0AA0	
Service&Support (Manuals, Certificates, Characteristics, FAQs,...) https://support.industry.siemens.com/cs/ww/en/ps/3SU1050-5PC01-0AA0	
Image database (product images, 2D dimension drawings, 3D models, device circuit diagrams, EPLAN macros, ...) https://www.automation.siemens.com/bilddb/cax_de.aspx?mlfb=3SU1050-5PC01-0AA0&lang=en	

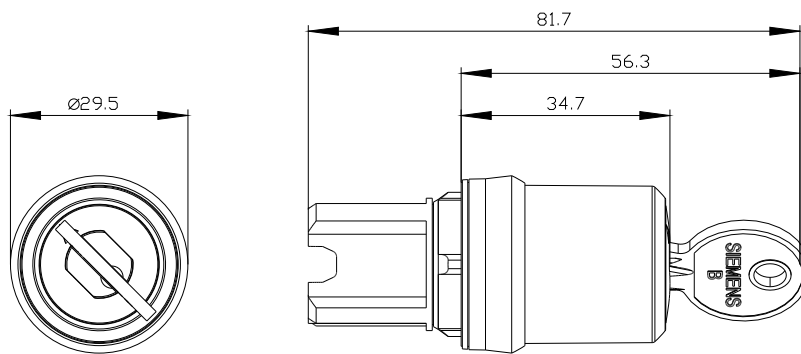

last modified:

7/6/2025 