









multifunction module, 4 inputs and 2 relay outputs, input voltage 110-240 V AC/DC
 relay outputs monostable, analog residual current detection, with residual-current transformer 3UL23 connection temperature sensor Pt100/Pt1000/KTY/NTC, max. 1 multifunction module per basic device SIMOCODE pro S

product brand name	SIRIUS
product designation	Multifunction module
manufacturer's article number	
<ul style="list-style-type: none"> • 1 of residual current transformer connectable • 2 of residual current transformer connectable • 3 of residual current transformer connectable • 4 of residual current transformer connectable • 5 of residual current transformer connectable • 6 of residual current transformer connectable 	3UL2302-1A 3UL2303-1A 3UL2304-1A 3UL2305-1A 3UL2306-1A 3UL2307-1A
General technical data	
product function residual current display	Yes
adjustable current response value current	40 ... 0.03 A
product component	
<ul style="list-style-type: none"> • input for thermistor connection • digital input • input for residual current converter • input for analog temperature sensors • input for ground fault detection • relay output 	No Yes Yes Yes Yes Yes
consumed active power	0.8 W
insulation voltage with degree of pollution 3 at AC rated value	300 V
surge voltage resistance rated value	4 000 V
shock resistance	
<ul style="list-style-type: none"> • when mounted on current measuring module according to IEC 60068-2-27 • according to IEC 60068-2-27 	10 g / 11 ms 15g / 11 ms
vibration resistance	
<ul style="list-style-type: none"> • according to IEC 60068-2-6 • when mounted on current measuring module according to IEC 60068-2-6 	1 ... 6 Hz: 15 mm, 6 ... 500 Hz: 2g 1 ... 4 Hz / 15 mm, 4 ... 500 Hz / 1g
switching capacity current of the NO contacts of the relay outputs at AC-15	
<ul style="list-style-type: none"> • at 24 V • at 120 V • at 230 V 	6 A 6 A 3 A
switching capacity current of the NO contacts of the relay outputs at DC-13	
<ul style="list-style-type: none"> • at 24 V • at 60 V • at 125 V 	2 A 0.55 A 0.25 A

mechanical service life (operating cycles) typical	10 000 000
electrical endurance (operating cycles) typical	100 000
buffering time in the event of power failure	0 s
reference code according to IEC 81346-2	K
continuous current of the NO contacts of the relay outputs <ul style="list-style-type: none"> • at 50 °C • at 60 °C 	6 A 5 A
Substance Prohibition (Date)	05/01/2012
SVHC substance name	Lead - 7439-92-1 Lead monoxide (lead oxide) - 1317-36-8
Weight	0.231 kg
measurable temperature <ul style="list-style-type: none"> • with NTC minimum • with NTC maximum • with KTY 84 minimum • with KTY 84 maximum • with KTY 83-110 minimum • with KTY 83-110 maximum • with Pt 1000 minimum • with Pt 1000 maximum • with Pt 100 minimum • with Pt 100 maximum 	80 °C 160 °C -40 °C 300 °C -50 °C 175 °C -50 °C 500 °C -50 °C 500 °C
relative temperature-related measurement deviation at 20 °C	2 %
sensor current for Pt 100 typical	1 mA
sensor current for Pt 1000/KTY 83-110/KTY 84/NTC typical	0.2 mA
diagnostics function at sensor input with Pt 100 <ul style="list-style-type: none"> • short-circuit detection • open-circuit detection 	Yes Yes
diagnostics function at sensor input with Pt 1000 <ul style="list-style-type: none"> • short-circuit detection • open-circuit detection 	Yes Yes
diagnostics function at sensor input with KTY 83-110 <ul style="list-style-type: none"> • short-circuit detection • open-circuit detection 	Yes Yes
diagnostics function at sensor input with KTY 84 <ul style="list-style-type: none"> • short-circuit detection • open-circuit detection 	Yes Yes
diagnostics function at sensor input with NTC <ul style="list-style-type: none"> • short-circuit detection • open-circuit detection 	Yes No
type of connection technology of sensor circuit	2-wire or 3-wire connection
A/D conversion time at sensor circuit	500 ms
measurable line frequency initial value	16 Hz
measurable line frequency full-scale value	400 Hz
Electromagnetic compatibility	
EMC emitted interference according to IEC 60947-1	class A
EMC immunity according to IEC 60947-1	corresponds to degree of severity 3
conducted interference <ul style="list-style-type: none"> • due to burst according to IEC 61000-4-4 • due to conductor-earth surge according to IEC 61000-4-5 • due to conductor-conductor surge according to IEC 61000-4-5 • due to high-frequency radiation according to IEC 61000-4-6 	2 kV (power ports) / 1 kV (signal ports) 2 kV 1 kV 10 V
field-based interference according to IEC 61000-4-3	10 V/m
electrostatic discharge according to IEC 61000-4-2	6 kV contact discharge / 8 kV air discharge
conducted HF interference emissions according to CISPR11	corresponds to degree of severity A
field-bound HF interference emission according to CISPR11	corresponds to degree of severity A

Inputs/ Outputs	
product function	
• parameterizable inputs	Yes
• parameterizable outputs	Yes
number of inputs	4
number of digital inputs	4
• with a common reference potential	4
digital input version	
• type 1 acc. to IEC 61131	No
• type 2 acc. to IEC 61131	Yes
number of analog inputs	0
number of sensor inputs	
• for ground fault detection	1
• for temperature measurement	1
input voltage at digital input at DC rated value	230 V
number of outputs	2
number of semiconductor outputs	0
number of outputs as contact-affected switching element	2
number of analog outputs	0
switching behavior	monostable
property of contacts of the relay outputs	Floating NO contacts (NC reaction parameterizable via internal signal conditioning), of which 2 relay outputs connected to common ground and one relay output separately, can be freely assigned to the control functions (e.g. line, star (wye), delta contactor or signaling of the operating state)
wire length for digital signals maximum	200 m
Protective and monitoring functions	
product function ground fault detection	Yes
type of current for monitoring	Type A (alternating currents and pulsing DC residual currents)
response time maximum	0 s
diagnostics function at sensor input with residual current transformer short-circuit detection	Yes
diagnostics function at sensor input with residual current transformer open-circuit detection	Yes
relative measurement deviation of residual current transformer	7.5 %
design of the sensor for temperature measurement connectable	PT100 / PT1000 / KTY83-110 / KTY84 / NTC
Precision	
temperature drift per °C	0.05 %/°C
Installation/ mounting/ dimensions	
mounting position	any
height	100 mm
width	22.5 mm
depth	124.5 mm
required spacing	
• top	40 mm
• bottom	40 mm
• left	0 mm
• right	0 mm
diameter of inlet opening of connectable residual current transformer	35 ... 210 mm
Connections/ Terminals	
product component removable terminal for auxiliary and control circuit	Yes
type of electrical connection for auxiliary and control circuit	screw-type terminals
type of connectable conductor cross-sections	
• solid	1x (0.5 ... 2.5 mm ²), 2x (0.5 ... 1.5 mm ²)
• finely stranded with core end processing	1x (0.5 ... 2.5 mm ²), 2x (0.5 ... 1.0 mm ²)
• for AWG cables solid	1x (20 ... 14), 2x (20 ... 16)
• for AWG cables stranded	1x (20 ... 12), 2x (20 ... 14)
tightening torque with screw-type terminals	0.6 ... 0.8 N·m
tightening torque [lbf·in] with screw-type terminals	5.2 ... 7 lbf·in

Ambient conditions		
installation altitude at height above sea level		
<ul style="list-style-type: none"> • 1 maximum • 2 maximum • 3 maximum 	2 000 m 3 000 m; max. +50 °C (no protective separation) 4 000 m; No protective separation at 40 °C	
ambient temperature		
<ul style="list-style-type: none"> • during operation • during storage • during transport 	-25 ... +60 °C -40 ... +80 °C -40 ... +80 °C	
environmental category		
<ul style="list-style-type: none"> • during operation according to IEC 60721 • during storage according to IEC 60721 • during transport according to IEC 60721 	3K6 (no formation of ice, no condensation, relative humidity 10 ... 95%), 3C3 (no salt mist), 3S2 (sand must not get into the devices), 3M6 1K6 (no condensation, relative humidity 10 ... 95%), 1C2 (no salt mist), 1S2 (sand must not get into the devices), 1M4 2K2, 2C1, 2S1, 2M2	
relative humidity during operation	10 ... 95 %	
contact rating of auxiliary contacts according to UL	B300 / R300	
Short-circuit protection		
design of short-circuit protection per output	Fuse links: gG 6 A, quick-response 10 A (IEC 60947-5-1), miniature circuit-breaker C char.: 1.6 A (IEC 60947-5-1) or 6 A (I _K < 500 A)	
Electrical Safety		
touch protection against electrical shock	finger-safe	
ATEX		
certificate of suitability according to ATEX directive 2014/34/EU	BVS 06 ATEX F001	
explosion device group and category according to ATEX directive 2014/34/EU	II (2) G, II (2) D, I (M2)	
Galvanic isolation		
(electrically) protective separation according to IEC 60947-1	All circuits with protective separation (double creepage paths and clearances), the information in the "Protective Separation" test report, No. A0258, must be observed (link see further information)	
galvanic isolation between inputs and electronics	No	
Control circuit/ Control		
type of voltage of the control supply voltage	AC/DC	
control supply voltage at AC		
<ul style="list-style-type: none"> • at 50 Hz rated value • at 60 Hz rated value 	110 ... 240 V 110 ... 240 V	
control supply voltage frequency 1	50 ... 60 Hz	
control supply voltage at DC rated value	110 ... 240 V	
operating range factor control supply voltage rated value at DC		
<ul style="list-style-type: none"> • initial value • full-scale value 	0.85 1.1	
operating range factor control supply voltage rated value at AC at 50 Hz		
<ul style="list-style-type: none"> • initial value • full-scale value 	0.85 1.1	
operating range factor control supply voltage rated value at AC at 60 Hz		
<ul style="list-style-type: none"> • initial value • full-scale value 	0.85 1.1	
Approvals Certificates		
General Product Approval	EMV	
     		
EMV	For use in hazardous locations	Test Certificates

[KC](#)



[Miscellaneous](#)

[Type Test Certificates/Test Report](#)

[Special Test Certificate](#)

Maritime application

other

Environment



[Confirmation](#)



[Environmental Confirmations](#)

Industrial Communication



Profibus

Further information

Information on the packaging

<https://support.industry.siemens.com/cs/ww/en/view/109813875>

Information for data generation and storage

<https://support.industry.siemens.com/cs/ww/en/view/109995012>

Information- and Downloadcenter (Catalogs, Brochures,...)

<https://www.siemens.com/ic10>

Industry Mall (Online ordering system)

<https://mall.industry.siemens.com/mall/en/en/Catalog/product?mlfb=3UF7600-1AU01-0>

Cax online generator

<https://support.automation.siemens.com/WW/CAXorder/default.aspx?lang=en&mlfb=3UF7600-1AU01-0>

Service&Support (Manuals, Certificates, Characteristics, FAQs,...)

<https://support.industry.siemens.com/cs/ww/en/ps/3UF7600-1AU01-0>

Image database (product images, 2D dimension drawings, 3D models, device circuit diagrams, EPLAN macros, ...)

https://www.automation.siemens.com/bilddb/cax_de.aspx?mlfb=3UF7600-1AU01-0&lang=en

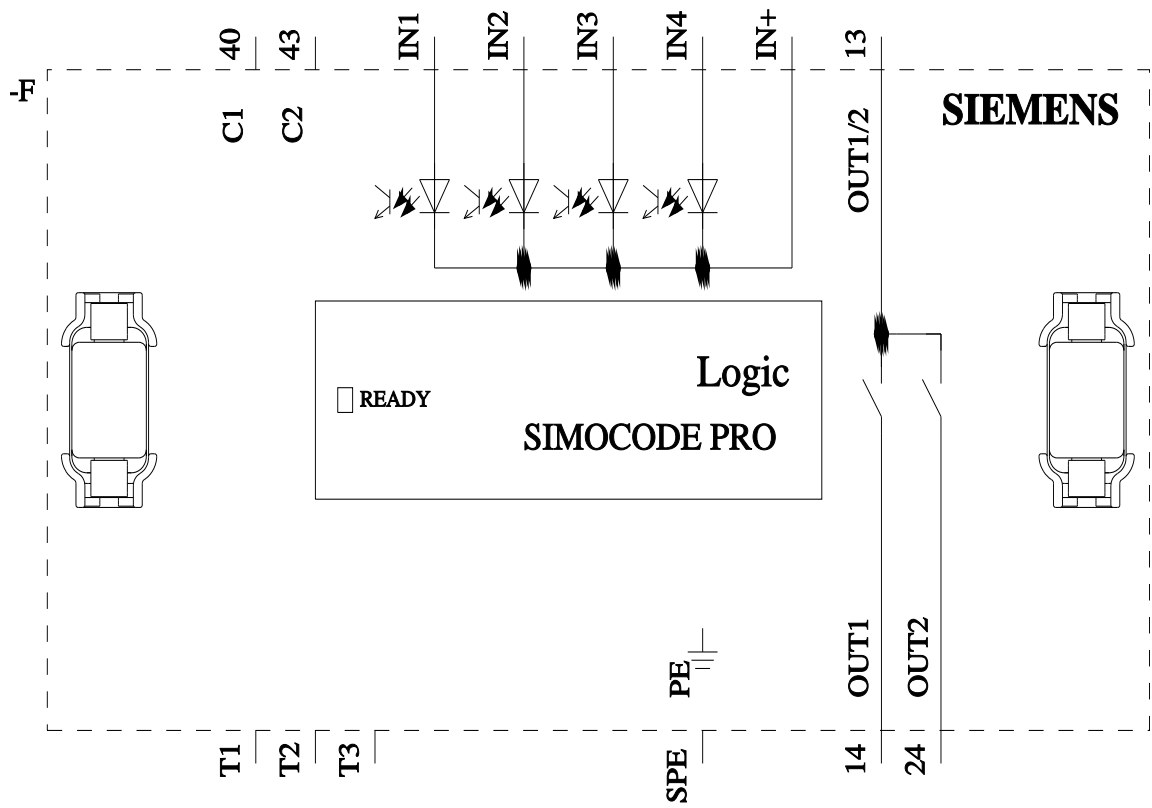
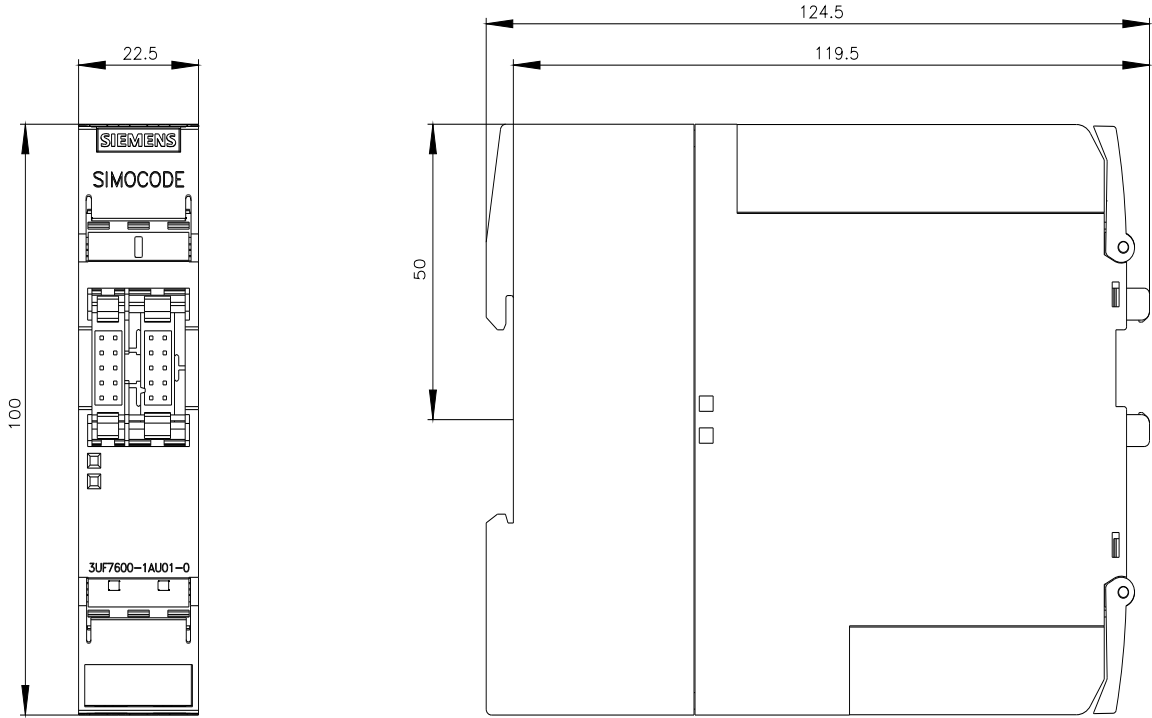

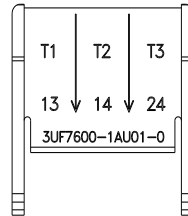
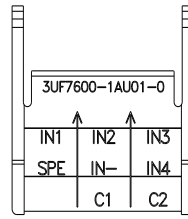
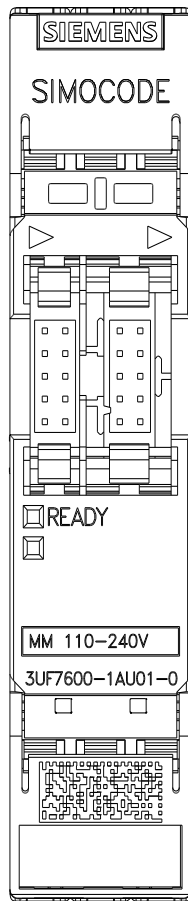

last modified:

4/2/2025