



circuit breaker 3VA5 UL Frame 250 breaking capacity class H 65 kA @ 480 V 4-pole, line protection TM230, FTAM, In=110 A overload protection Ir=110 A permanently set short-circuit protection Ii=5...10 x In neutral conductor protection 100% without connection

Model	
product brand name	SENTRON
product designation	Molded-case circuit breaker
product designation / according to UL file	HFAS
design of the product	System protection
design of the load switch / according to UL 489 / Heating, Air Conditioning, and Refrigeration circuit breaker (HACR Type)	Yes
design of the load switch / according to UL 489 / High-Intensity-Discharge circuit breaker (HID Type)	No
design of the load switch / according to UL 489 / Switching Duty circuit breaker (SWD Type)	No
design of the overcurrent release	TM230
protection function of the overcurrent release	LI
number of poles	4
General technical data	
insulation voltage / rated value	800 V
operating voltage / at DC / rated value	1 000 V
operating voltage / at AC / rated value	690 V
power loss [W] / maximum	23 W
power loss [W] / for rated value of the current / at AC / in hot operating state / per pole	7.53 W
mechanical service life (operating cycles) / typical	20 000
electrical endurance (operating cycles) / at AC-1 / at 380/415 V	8 000
electrical endurance (operating cycles) / at AC-1 / at 690 V	4 000
electrical endurance (operating cycles) / at 480 V	8 000
electrical endurance (operating cycles) / at 600 V	4 000
product feature / for neutral conductors / upgradable/retrofitable / short-circuit and overload proof	No
product function	
• communication function	No
• other measurement function	No
Net Weight	2.55 kg
Current	
marking / according to UL 489 / 100%-rated breaker	No
operational current	
• at 40 °C	110 A
• at 45 °C	107 A
• at 50 °C	104 A
• at 55 °C	100 A
• at 60 °C	97 A

<ul style="list-style-type: none"> • at 65 °C • at 70 °C 	94 A 91 A
Switching capacity according to IEC 60947	
switching capacity class of the circuit breaker	H
maximum short-circuit current breaking capacity (I _{cu}) <ul style="list-style-type: none"> • at 240 V • at 415 V • at 690 V 	100 kA 70 kA 10 kA
operating short-circuit current breaking capacity (I _{cs}) <ul style="list-style-type: none"> • at 240 V • at 415 V • at 690 V 	100 kA 70 kA 10 kA
short-circuit current making capacity (I _{cm}) <ul style="list-style-type: none"> • at 240 V • at 415 V • at 690 V 	220 kA 154 kA 17 kA
design of short-circuit protection	For switching power values in DC networks, see the 3VA molded case circuit breaker device manual; link to be found under Service & Support in the last chapter
Switching capacity according to UL 489	
current breaking capacity <ul style="list-style-type: none"> • at 240 V • at 480 V • at 600 V 	100 kA 65 kA 25 kA
Adjustable parameters	
adjustable response value setting current (I _r) / of the L-trip / with I ² t characteristic <ul style="list-style-type: none"> • minimum • maximum 	110 A 110 A
adjustable response value delay time (t _r) / for L-tripping / with I ² t characteristic <ul style="list-style-type: none"> • minimum • maximum 	1 s 1 s
adjustable response value setting current (I _i) / for I-tripping <ul style="list-style-type: none"> • minimum • maximum 	550 A 1 100 A
adjustable setting current (I _{nN}) / for N-tripping <ul style="list-style-type: none"> • minimum • maximum 	110 A 110 A
design of the N-conductor protection	100%
product function / grounding protection	No
Mechanical Design	
product component <ul style="list-style-type: none"> • undervoltage release • voltage trigger • trip indicator 	No No No
height [in]	7.28 in
height	185 mm
width [in]	5.51 in
width	140 mm
depth [in]	3.27 in
depth	83 mm
Connections	
arrangement of electrical connectors / for main current circuit	Without connection
type of electrical connection / for main current circuit	Without
Auxiliary circuit	
number of CO contacts / for auxiliary contacts	0
Accessories	
product extension / optional / motor drive	Yes
Environmental conditions	

protection class IP / on the front	IP40
ambient temperature	
• during operation / minimum	-25 °C
• during operation / maximum	70 °C
• during storage / minimum	-40 °C
• during storage / maximum	80 °C
reference code / according to IEC 81346-2	Q

Approvals / Certificates

General Product Approval



[Miscellaneous](#)

General Product Approval	EMV	Maritime application	other
--------------------------	-----	----------------------	-------



[Confirmation](#)

[Miscellaneous](#)

Environment

[Environmental Confirmations](#)

Further information

Information on the packaging

<https://support.industry.siemens.com/cs/ww/en/view/109813875>

Information for data generation and storage

<https://support.industry.siemens.com/cs/ww/en/view/109995012>

Information- and Downloadcenter (Catalogs, Brochures,...)

<https://www.siemens.com/lowvoltage/catalogs>

Industry Mall (Online ordering system)

<https://mall.industry.siemens.com/mall/en/en/Catalog/product?mlfb=3VA5211-6GC41-0AA0>

Service&Support (Manuals, Certificates, Characteristics, FAQs,...)

<https://support.industry.siemens.com/cs/ww/en/ps/3VA5211-6GC41-0AA0>

Image database (product images, 2D dimension drawings, 3D models, device circuit diagrams, ...)

https://www.automation.siemens.com/bilddb/cax_en.aspx?mlfb=3VA5211-6GC41-0AA0

CAX-Online-Generator

<https://www.siemens.com/cax>

Tender specifications

<https://www.siemens.com/specifications>

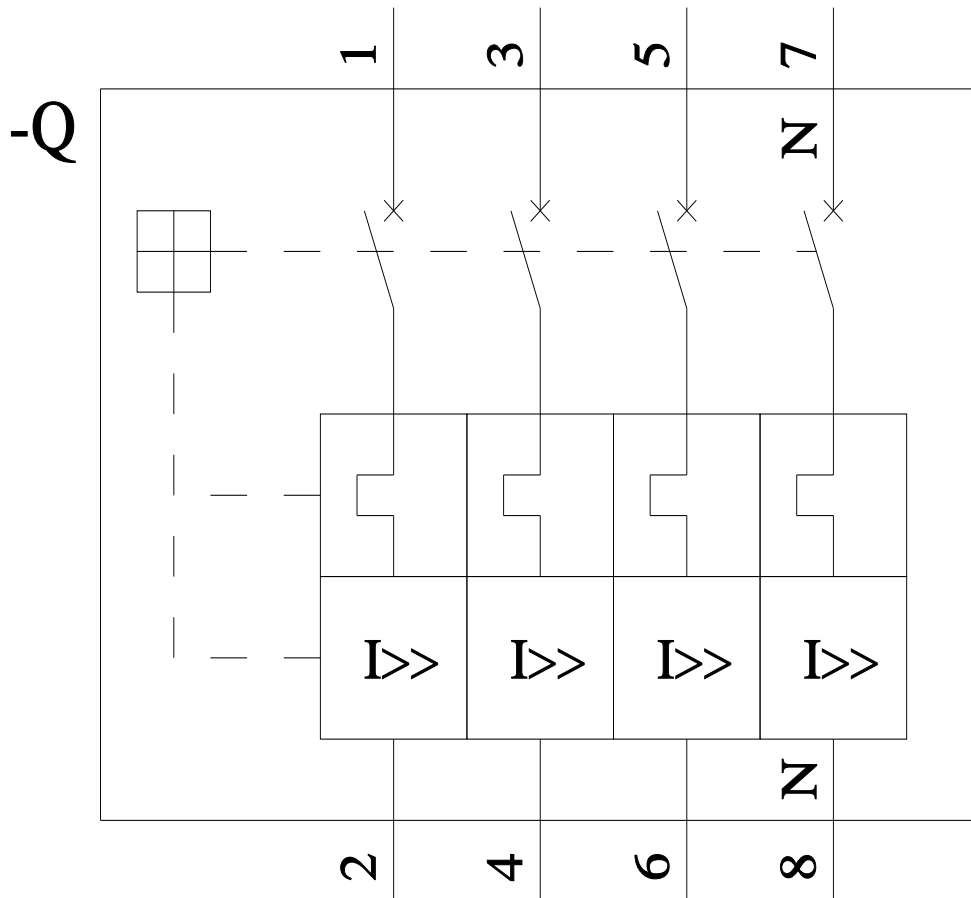
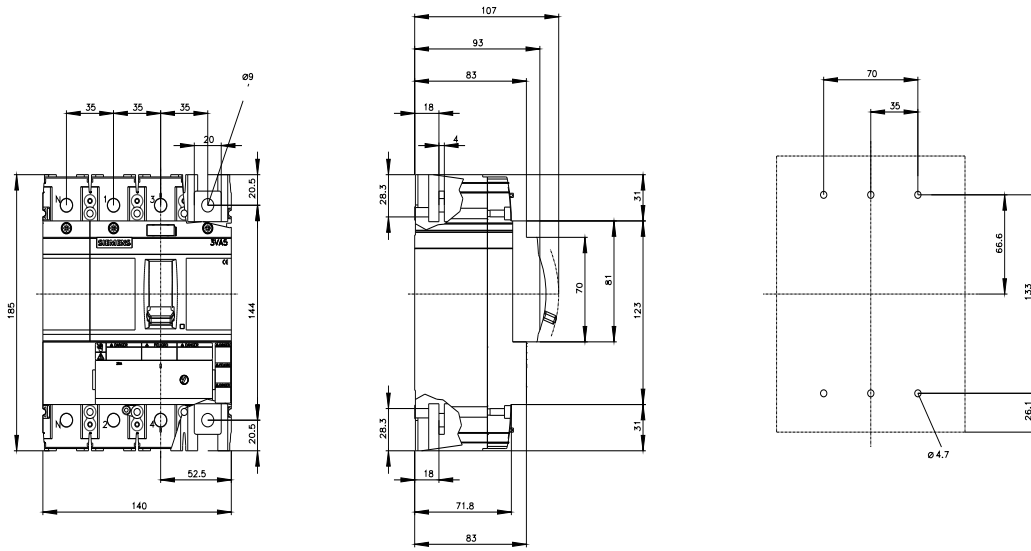



last modified:

3/31/2025 

