







front mounted rotary operator standard IEC IP30/40 24 V DC lighting kit accessory for: 3VA52; 3VA61/62



Model				
product brand name	SETRON			
product designation	front rotary operating mechanism			
accessories	Front rotary operator			
General technical data				
degree of protection NEMA rating	1			
protection class IP	IP30			
Mechanical Design				
height	82 mm			
width	105 mm			
depth	106 mm			
Net Weight	310 g			
Certificates				
General Product Approval				
Confirmation	  			
	Miscellaneous 			
EMV	Test Certificates	Maritime application	other	Environment
	Type Test Certificates/Test Report		Confirmation	Miscellaneous
			Confirmation	Environmental Confirmations
Environment				
Environmental Confirmations				
Further information				
Information on the packaging https://support.industry.siemens.com/cs/ww/en/view/109813875				
Information for data generation and storage https://support.industry.siemens.com/cs/ww/en/view/109995012				
Information- and Downloadcenter (Catalogs, Brochures,...)				

<https://www.siemens.com/lowvoltage/catalogs>

Industry Mall (Online ordering system)

<https://mall.industry.siemens.com/mall/en/en/Catalog/product?mlfb=3VA9277-0EK13>

Service&Support (Manuals, Certificates, Characteristics, FAQs,...)

<https://support.industry.siemens.com/cs/ww/en/ps/3VA9277-0EK13>

Image database (product images, 2D dimension drawings, 3D models, device circuit diagrams, ...)

https://www.automation.siemens.com/bilddb/cax_en.aspx?mlfb=3VA9277-0EK13

CAX-Online-Generator

<https://www.siemens.com/cax>

Tender specifications

<https://www.siemens.com/specifications>

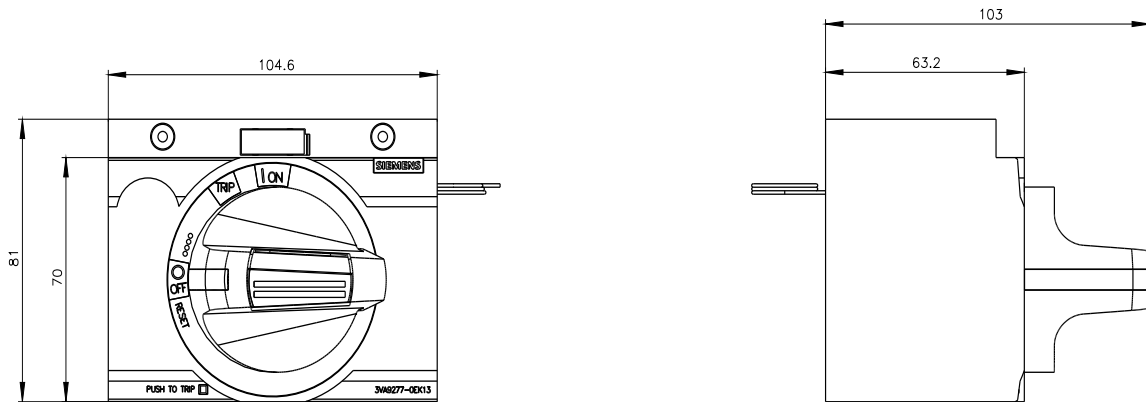



last modified:

4/3/2025 