



residual current device RCD820 advanced RCD type A loadside mounted rated resid. current 0.03...30A at 50/60 Hz adjustable tv 0...10000 ms 4-pole In=630 A Ue=100-690 V accessory for: 3VA2

Model	
product brand name	SENTRON
product designation	Residual current protection device type A
accessories	Residual current protection module type A
General technical data	
fastening method	screw fixing
number of poles	4
protection class IP / on the front	IP40
Voltage	
supply voltage / at AC	
• minimum	127 V
• maximum	690 V
Current	
operational current / at AC / rated value	630 A
response value / of the residual current	0.03;0.05;0.1;0.3;0.5;1;3;5;10;30
product function / communication with residual current equipment	Yes
• product function / integrated / alarm management	Yes
• product function / integrated / alarm management	Pre-alarm indication 30% and 60%
• product function / remote-controlled tripping	Yes
• product feature / sealable	Yes
• product function / selectable tripping characteristic	No
• product function / selectable RCD or monitoring mode	Yes
position / of the infeed / on the RCD component	Top or bottom
type of electrical connection / for main current circuit	busbar connection
set values / of the limit value of not tripping time	0;0.06;0.15;0.3;0.5;1.0;2.0;3.0;5.0;10.0
type of trip indicator / electrical	Yes
type of trip indicator / communication	Yes
power loss [W] / maximum	66 W
operating frequency / rated value / maximum	60 Hz
frequency / of fault current	
• minimum	50 Hz
• maximum	60 Hz
Mechanical Design	
height	150 mm
width	184 mm
depth	110 mm
net weight	3 598 g

Net Weight	3.641 kg
Connections according UL	
ambient temperature / during operation	
• minimum	-25 °C
• maximum	70 °C
ambient temperature / during storage	
• minimum	-40 °C
• maximum	80 °C

Certificates

General Product Approval



[Miscellaneous](#)



EMV	Maritime application	other	Dangerous goods	Environment
-----	----------------------	-------	-----------------	-------------



[Confirmation](#)

[Miscellaneous](#)

[Transport Information](#)



Environment

[Environmental Confirmations](#)

[Environmental Confirmations](#)

Further information

Information on the packaging

<https://support.industry.siemens.com/cs/ww/en/view/109813875>

Information for data generation and storage

<https://support.industry.siemens.com/cs/ww/en/view/109995012>

Information- and Downloadcenter (Catalogs, Brochures,...)

<https://www.siemens.com/lowvoltage/catalogs>

Industry Mall (Online ordering system)

<https://mall.industry.siemens.com/mall/en/en/Catalog/product?mlfb=3VA9424-0RL30>

Service&Support (Manuals, Certificates, Characteristics, FAQs,...)

<https://support.industry.siemens.com/cs/ww/en/ps/3VA9424-0RL30>

Image database (product images, 2D dimension drawings, 3D models, device circuit diagrams, ...)

https://www.automation.siemens.com/bilddb/cax_en.aspx?mlfb=3VA9424-0RL30

CAx-Online-Generator

<https://www.siemens.com/cax>

Tender specifications

<https://www.siemens.com/specifications>

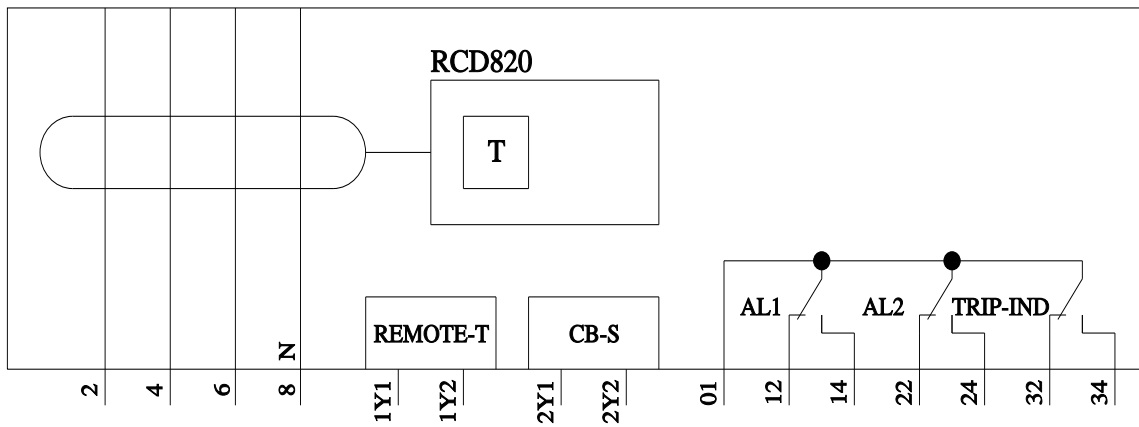
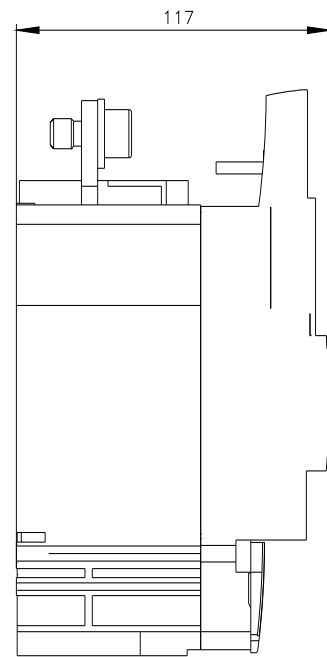
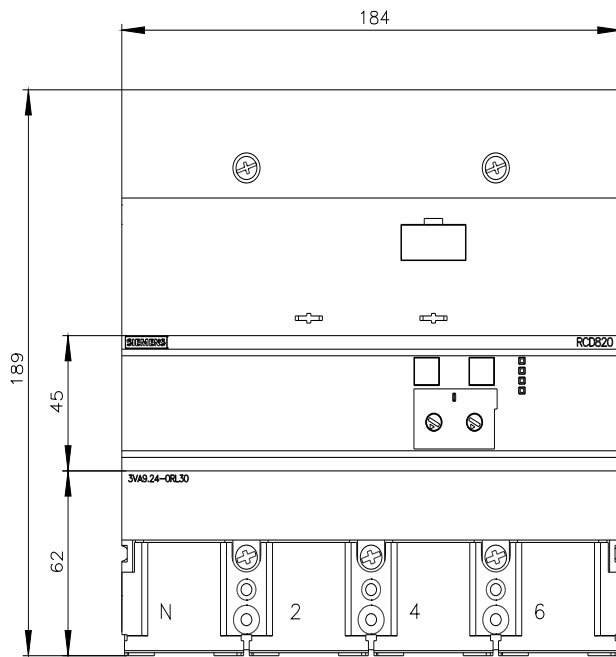

last modified:

4/3/2025

