









Accessory 3WA/3WL Charging Motor (M) 24-30 V DC

Model	
product brand name	SENTRON
product designation	Motorized operating mechanism
design of the product	MO spring charging motor
operating apparent power [VA]	135 VA
electrical endurance (operating cycles)	30 000
operating frequency maximum	60 1/h
time for clamping of the spring energy store with control supply voltage (Us)	10 s
control supply voltage at DC rated value maximum	30 V
design of the DIAZED fuse link gG for short-circuit protection minimum permissible	6 A (fuse gG: 6 A, miniature circuit breaker C characteristic: 6 A)
Net Weight	1.562 kg
ambient temperature during operation	
• minimum	-40 °C
• maximum	70 °C
ambient temperature during storage	
• minimum	-40 °C
• maximum	80 °C

**Approvals Certificates**

General Product Approval		EMV	Test Certificates		
					<a href="#">Miscellaneous</a>
<a href="#">Type Test Certificates/Test Report</a>	<a href="#">Special Test Certificate</a>			<a href="#">Confirmation</a>	<a href="#">Dangerous goods information</a>

**Dangerous goods**

[Transport Information](#)

## Further information

### Information on the packaging

<https://support.industry.siemens.com/cs/ww/en/view/109813875>

### Information for data generation and storage

<https://support.industry.siemens.com/cs/ww/en/view/109995012>

### Information- and Downloadcenter (Catalogs, Brochures,...)

<https://www.siemens.com/lowvoltage/catalogs>

### Industry Mall (Online ordering system)

<https://mall.industry.siemens.com/mall/en/en/Catalog/product?mlfb=3WA9111-0AF02>

### Service&Support (Manuals, Certificates, Characteristics, FAQs,...)

<https://support.industry.siemens.com/cs/ww/en/ps/3WA9111-0AF02>

### Image database (product images, 2D dimension drawings, 3D models, device circuit diagrams, ...)

[https://www.automation.siemens.com/bilddb/cax\\_en.aspx?mlfb=3WA9111-0AF02](https://www.automation.siemens.com/bilddb/cax_en.aspx?mlfb=3WA9111-0AF02)

### CAX-Online-Generator

<https://www.siemens.com/cax>

### Tender specifications

<https://www.siemens.com/specifications>

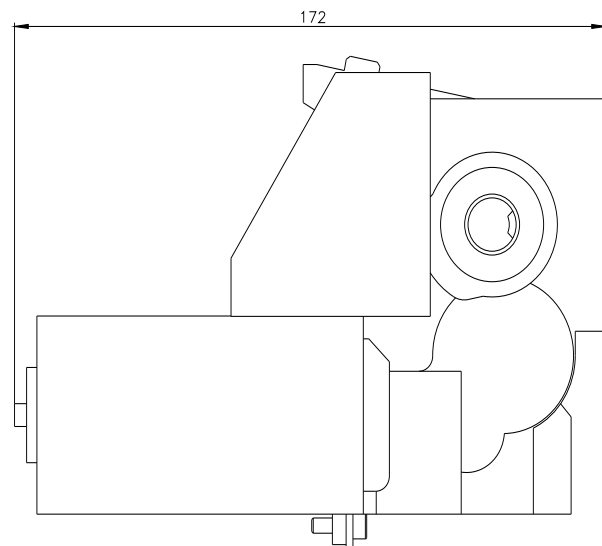
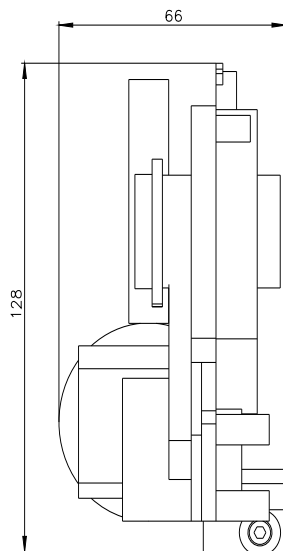

last modified:

8/5/2025 

