









Accessory Circuit breaker 3WA, Operations counter for manually operated circuit breaker

Model	
product brand name	SETRON
product designation	mechanical operating cycles counter
design of the product	mechanical operating cycles counter with manual operating mechanism
Net Weight	200 g

### Approvals Certificates

General Product Approval	EMV	Test Certificates
 	<a href="#">Confirmation</a> 	 <a href="#">Type Test Certificates/Test Report</a>

Test Certificates	Maritime application	other	Dangerous goods
<a href="#">Special Test Certificate</a>			<a href="#">Dangerous goods information</a>

### Further information

- Information on the packaging  
<https://support.industry.siemens.com/cs/ww/en/view/109813875>
- Information for data generation and storage  
<https://support.industry.siemens.com/cs/ww/en/view/109995012>
- Information- and Downloadcenter (Catalogs, Brochures,...)  
<https://www.siemens.com/lowvoltage/catalogs>
- Industry Mall (Online ordering system)  
<https://mall.industry.siemens.com/mall/en/en/Catalog/product?mlfb=3WA9111-0AH04>
- Service&Support (Manuals, Certificates, Characteristics, FAQs,...)  
<https://support.industry.siemens.com/cs/ww/en/ps/3WA9111-0AH04>
- Image database (product images, 2D dimension drawings, 3D models, device circuit diagrams, ...)  
[https://www.automation.siemens.com/bilddb/cax\\_en.aspx?mlfb=3WA9111-0AH04](https://www.automation.siemens.com/bilddb/cax_en.aspx?mlfb=3WA9111-0AH04)
- CAx-Online-Generator  
<https://www.siemens.com/cax>
- Tender specifications  
<https://www.siemens.com/specifications>

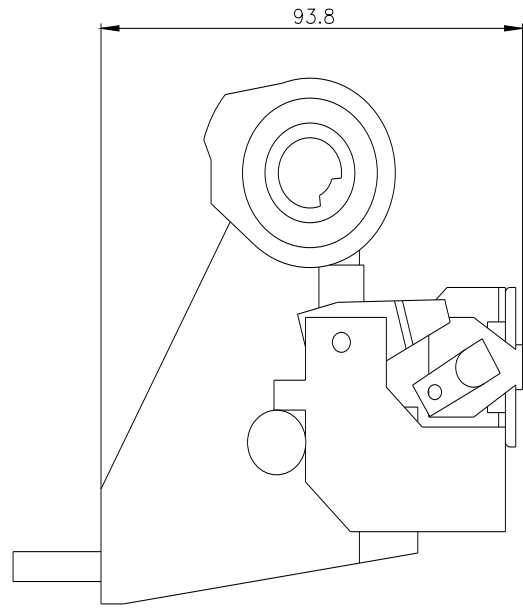
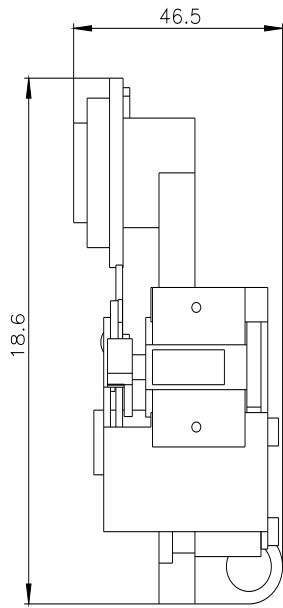

---

last modified:

4/13/2025 

