







Accessory Circuit breaker 3WA, Local electric close with sealing cover



Model	
product brand name	SENTRON
product designation	Local electric close
design of the product	local electric close with sealing cap
Net Weight	88 g

Approvals Certificates

General Product Approval	EMV	Test Certificates	
  		Miscellaneous	Type Test Certificates/Test Report
Test Certificates	Maritime application	other	Dangerous goods
Special Test Certificate			Dangerous goods information

Further information

- Information on the packaging <https://support.industry.siemens.com/cs/ww/en/view/109813875>
- Information for data generation and storage <https://support.industry.siemens.com/cs/ww/en/view/109995012>
- Information- and Downloadcenter (Catalogs, Brochures,...) <https://www.siemens.com/lowvoltage/catalogs>
- Industry Mall (Online ordering system) <https://mall.industry.siemens.com/mall/en/en/Catalog/product?mlfb=3WA9111-0AH21>
- Service&Support (Manuals, Certificates, Characteristics, FAQs,...) <https://support.industry.siemens.com/cs/ww/en/ps/3WA9111-0AH21>
- Image database (product images, 2D dimension drawings, 3D models, device circuit diagrams, ...) https://www.automation.siemens.com/bilddb/cax_en.aspx?mlfb=3WA9111-0AH21
- CAx-Online-Generator <https://www.siemens.com/cax>
- Tender specifications <https://www.siemens.com/specifications>

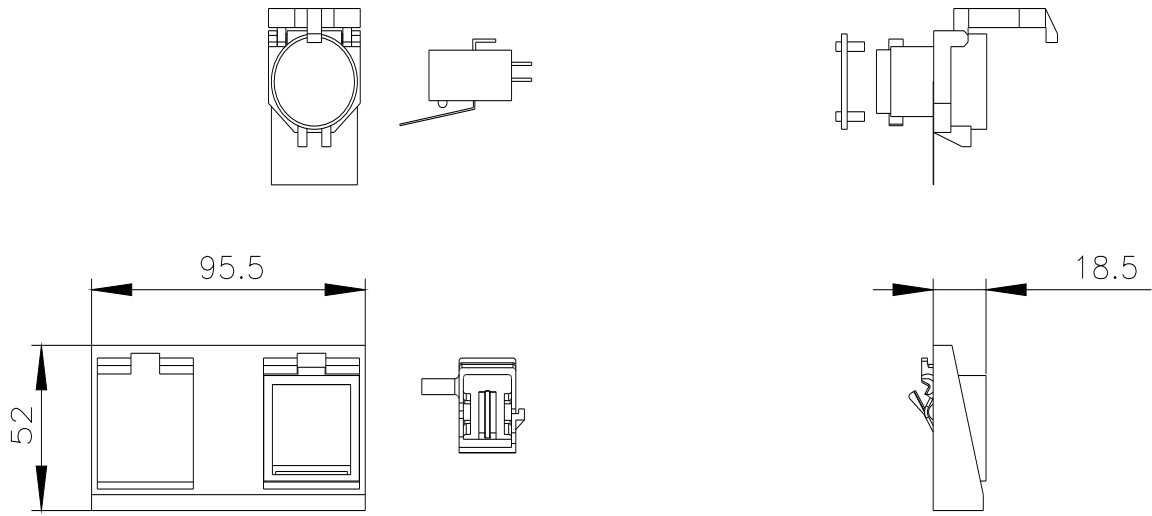

last modified:

4/13/2025 

