







Accessory Circuit breaker 3WA, Local electric close with IKON lock



| Model | |
|-----------------------|--|
| product brand name | SETRON |
| product designation | Local electric close |
| design of the product | local electric close, key operation with IKON lock |
| Net Weight | 185.44 g |

Approvals Certificates

| General Product Approval | EMV | Test Certificates | | |
|---|---|---|--|---|
|    |  | Miscellaneous | Special Test Certificate | |
| Test Certificates | Maritime application | other | Dangerous goods | |
| Type Test Certificates/Test Report |  |  | Confirmation | Dangerous goods information |

Further information

- Information on the packaging <https://support.industry.siemens.com/cs/ww/en/view/109813875>
- Information for data generation and storage <https://support.industry.siemens.com/cs/ww/en/view/109995012>
- Information- and Downloadcenter (Catalogs, Brochures,...) <https://www.siemens.com/lowvoltage/catalogs>
- Industry Mall (Online ordering system) <https://mall.industry.siemens.com/mall/en/en/Catalog/product?mlfb=3WA9111-0AH23>
- Service&Support (Manuals, Certificates, Characteristics, FAQs,...) <https://support.industry.siemens.com/cs/ww/en/ps/3WA9111-0AH23>
- Image database (product images, 2D dimension drawings, 3D models, device circuit diagrams, ...) https://www.automation.siemens.com/bilddb/cax_en.aspx?mlfb=3WA9111-0AH23
- CAx-Online-Generator <https://www.siemens.com/cax>
- Tender specifications <https://www.siemens.com/specifications>

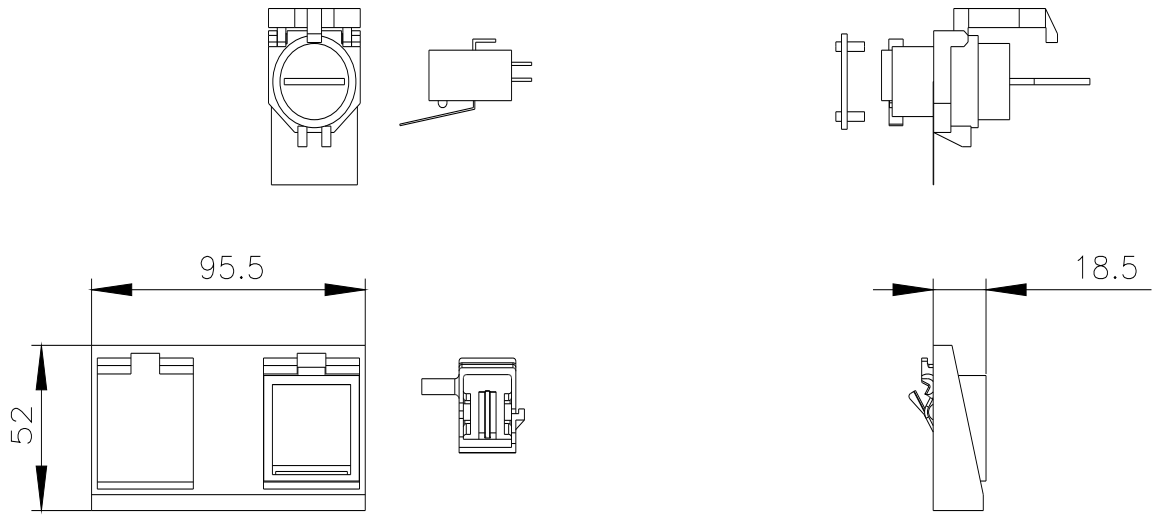

last modified:

4/13/2025 

