













Front Connectors (top) for circuit breakers fixed mounted, Frame Size 1, for 3WA2 breaking capacity class N / S, In = 1600A, for 3WA3 breaking capacity class N / S, In = 1600A, 1 piece (incl. hardware)

Model			
product brand name	SENTRON		
Net Weight	2.339 kg		
Approvals Certificates			
General Product Approval	EMV	Test Certificates	
  <small>EG-Konf.</small>	<a href="#">Confirmation</a>		 <small>RCM</small>
			
Test Certificates	Maritime application	other	Dangerous goods
<a href="#">Miscellaneous</a>	 <small>LRS</small>	<a href="#">Confirmation</a>	 <small>产品合格 QC PASS</small>
<a href="#">Dangerous goods information</a>			

### Further information

- Information on the packaging  
<https://support.industry.siemens.com/cs/ww/en/view/109813875>
- Information for data generation and storage  
<https://support.industry.siemens.com/cs/ww/en/view/109995012>
- Information- and Downloadcenter (Catalogs, Brochures,...)  
<https://www.siemens.com/lowvoltage/catalogs>
- Industry Mall (Online ordering system)  
<https://mall.industry.siemens.com/mall/en/en/Catalog/product?mlfb=3WA9111-1AF11>
- Service&Support (Manuals, Certificates, Characteristics, FAQs,...)  
<https://support.industry.siemens.com/cs/ww/en/ps/3WA9111-1AF11>
- Image database (product images, 2D dimension drawings, 3D models, device circuit diagrams, ...)  
[https://www.automation.siemens.com/bilddb/cax\\_en.aspx?mlfb=3WA9111-1AF11](https://www.automation.siemens.com/bilddb/cax_en.aspx?mlfb=3WA9111-1AF11)
- CAX-Online-Generator  
<https://www.siemens.com/cax>
- Tender specifications  
<https://www.siemens.com/specifications>

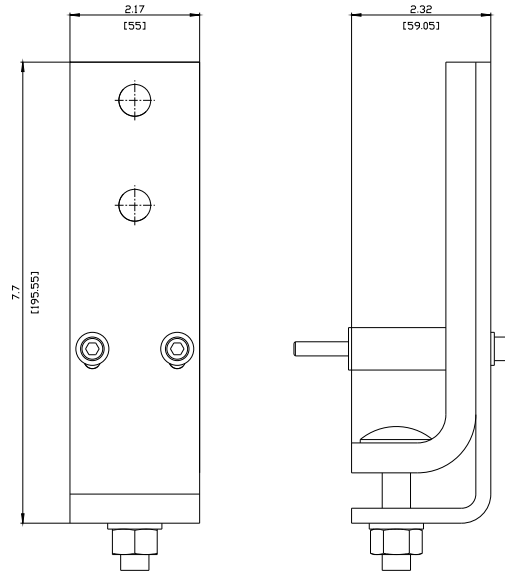

---

last modified:

11/25/2025 

