

NEOZED, fuse base, D01, 3-pole, 16 A, Un AC: 400 V, Un DC: 250 V with LED signal detector with frame terminal



Figure similar

Model	
product brand name	SENTRON
design of the product	NEOZED fuse base installation
General technical data	
number of poles	3
size of fuse system according to EN 60269-1	D01
Supply voltage	
operating voltage rated value	400 V
Dissipation	
power loss [W] for rated value of the current at AC in hot operating state per pole	0.6 W
Main circuit	
operational current rated value	16 A
Product details	
product component cover	Yes
Mechanical Design	
height	67 mm
width	81 mm
depth	55 mm
fastening method	DIN rail
Net Weight	
material of D fuse base	plastic
Approvals Certificates	
General Product Approval	other



[Confirmation](#)

Environment

[Environmental Con-
firmations](#)

[Environmental Con-
firmations](#)

Further information

Information on the packaging

<https://support.industry.siemens.com/cs/ww/en/view/109813875>

Information for data generation and storage

<https://support.industry.siemens.com/cs/ww/en/view/109995012>

Information- and Downloadcenter (Catalogs, Brochures,...)

<https://www.siemens.com/lowvoltage/catalogs>

Industry Mall (Online ordering system)

<https://mall.industry.siemens.com/mall/en/en/Catalog/product?mlfb=5SG5302-1>

Service&Support (Manuals, Certificates, Characteristics, FAQs,...)

<https://support.industry.siemens.com/cs/ww/en/ps/5SG5302-1>

Image database (product images, 2D dimension drawings, 3D models, device circuit diagrams, ...)

https://www.automation.siemens.com/bilddb/cax_en.aspx?mlfb=5SG5302-1

CAX-Online-Generator

<https://www.siemens.com/cax>

Tender specifications

<https://www.siemens.com/specifications>

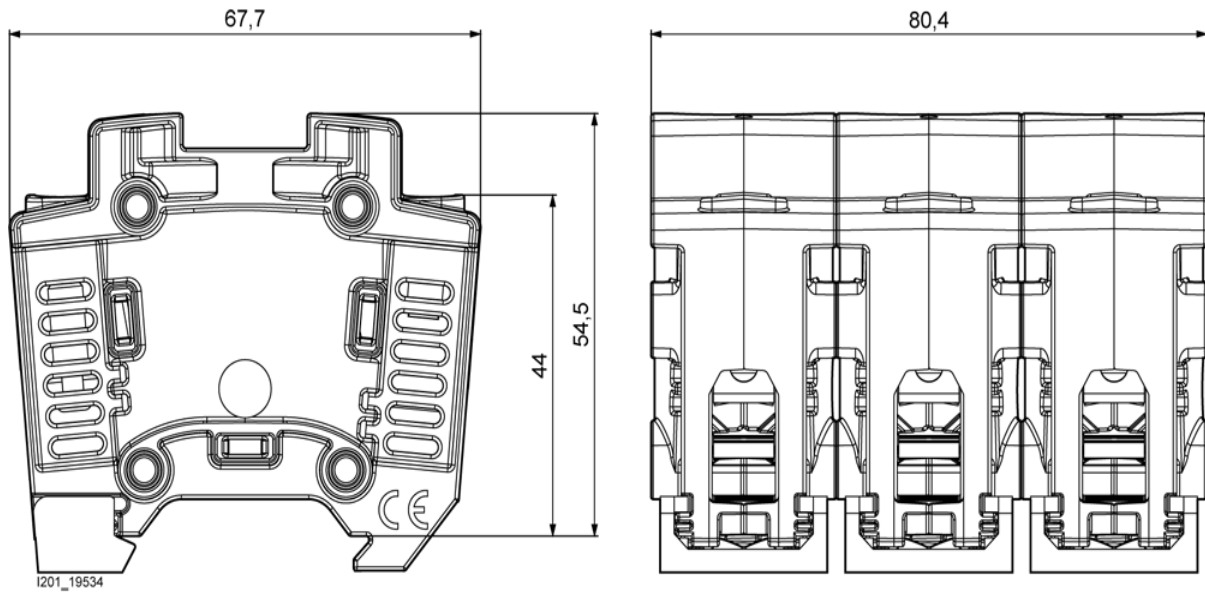

last modified:

11/19/2025

