



Arc fault detection device block AFDD, 1-40 A 230 V for CB and RCBO 1+N 2MW

Model	
product brand name	SENTRON
product designation	Arc fault detection unit
design of the product	for MCB 5SY, 5SL4 and RCBO 5SU1
General technical data	
number of poles	2
design of pole	1P+N
size of installation devices according to DIN 43880	1
touch protection against electrical shock according to EN 50274	finger and back-of-hand safe
mechanical service life (operating cycles) typical	10 000
switching function short-term delayed	No
overvoltage category	3
degree of pollution	2
type of voltage of the operating voltage	AC
Supply voltage	
supply voltage	
• at AC	230 V
value range of the supply voltage frequency	50Hz
Protection class	
protection class IP	IP20, with connected protective device and conductors
Product details	
product feature halogen-free	Yes
product feature silicon-free	Yes
product extension installable supplementary devices	Yes
Connections	
connectable conductor cross-section solid	
• minimum	0.75 mm ²
• maximum	16 mm ²
connectable conductor cross-section stranded	
• minimum	0.75 mm ²
• maximum	16 mm ²
connectable conductor cross-section finely stranded with core end processing	
• minimum	0.75 mm ²
• maximum	10 mm ²
tightening torque with screw-type terminals	
• minimum	2 N·m
• maximum	2.5 N·m

position of power supply cord	Bottom
Mechanical Design	
height	95 mm
width	54 mm
depth	68.5 mm
installation depth	70 mm
number of modular width units	1
number of modular width units of the mountable protective device	2
fastening method	DIN rail
mounting position	any
Net Weight	103 g

Environmental conditions	
ambient temperature during operation	
• minimum	-25 °C
• maximum	45 °C
ambient temperature during storage	
• minimum	-40 °C
• maximum	75 °C
ambient temperature with relative humidity 95%	55 °C
number of test cycles for environmental testing according to IEC 60068-2-30	28

Certificates	
reference code according to IEC 81346-2	F

Approvals Certificates

General Product Approval



[Confirmation](#)



General Product Approval	Test Certificates	other	Environment
--------------------------	-------------------	-------	-------------



[Miscellaneous](#)

[Confirmation](#)



[Miscellaneous](#)

[Environmental Confirmations](#)

Environment

[Environmental Confirmations](#)

Further information

- Information on the packaging
<https://support.industry.siemens.com/cs/ww/en/view/109813875>
- Information for data generation and storage
<https://support.industry.siemens.com/cs/ww/en/view/109995012>
- Information- and Downloadcenter (Catalogs, Brochures,...)
<https://www.siemens.com/lowvoltage/catalogs>
- Industry Mall (Online ordering system)
<https://mall.industry.siemens.com/mall/en/en/Catalog/product?mlfb=5SM6024-2>
- Service&Support (Manuals, Certificates, Characteristics, FAQs,...)
<https://support.industry.siemens.com/cs/ww/en/ps/5SM6024-2>
- Image database (product images, 2D dimension drawings, 3D models, device circuit diagrams, ...)
https://www.automation.siemens.com/bilddb/cax_en.aspx?mlfb=5SM6024-2
- CAX-Online-Generator
<https://www.siemens.com/cax>
- Tender specifications

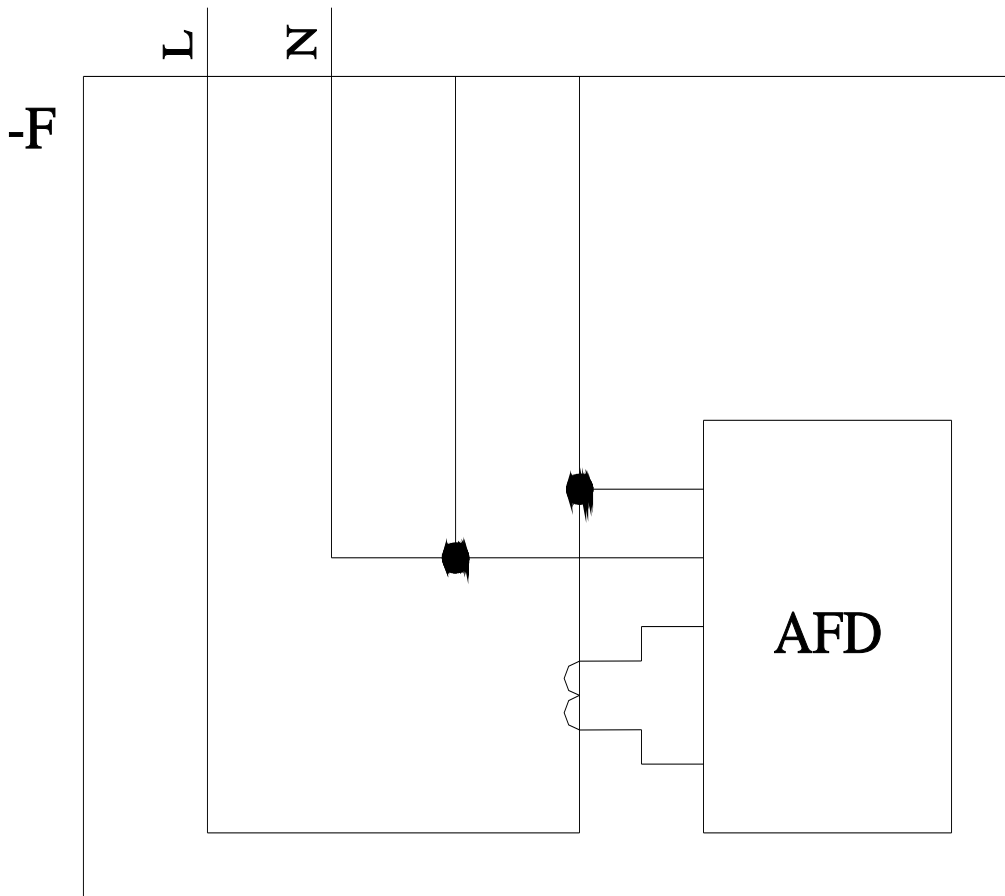
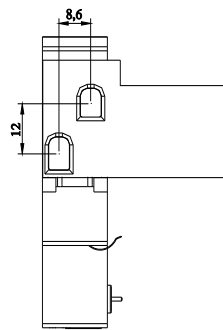
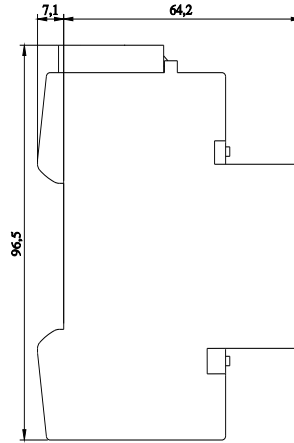
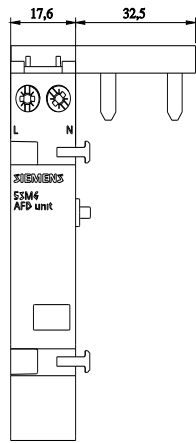

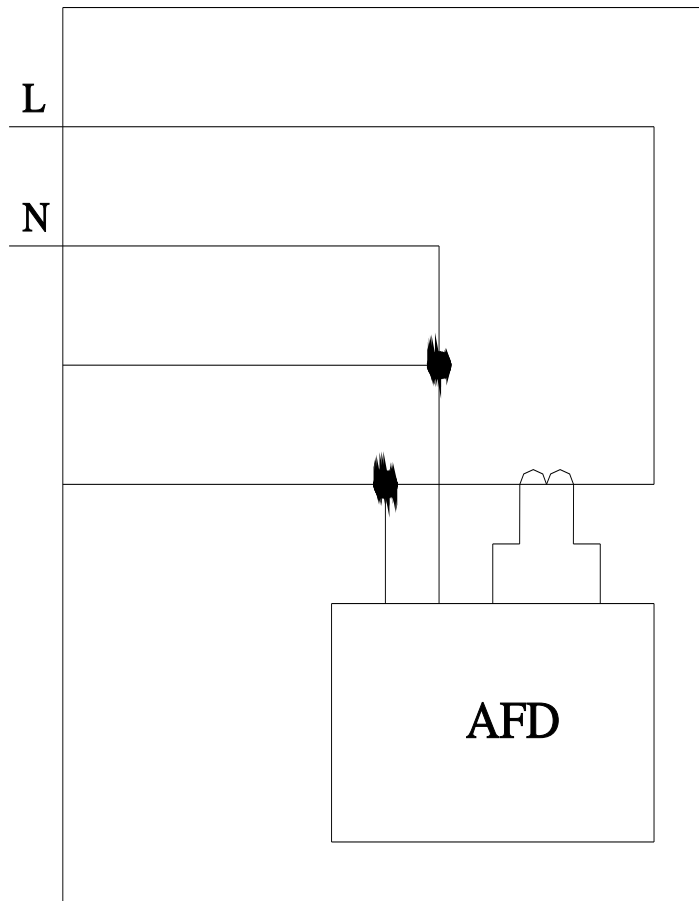

last modified:

7/19/2025 

