



5SV6 AFDD/RCB 6kA B16 1+N 1MW Big Pack 12 pcs

Figure similar

Model	
product brand name	SENTRON
product designation	AFDD/RCB
design of the product	Compact unit
General technical data	
number of poles	2
design of pole	1P+N
tripping characteristic class	B
size of installation devices according to DIN 43880	1
touch protection against electrical shock according to EN 50274	finger and back-of-hand safe
mechanical service life (operating cycles) typical	10 000
switching function short-term delayed	No
overvoltage category	3
degree of pollution	2
type of voltage of the operating voltage	AC
Supply voltage	
supply voltage	
• at AC	230 V
value range of the supply voltage frequency	50Hz
Protection class	
protection class IP	IP20, with connected protective device and conductors
Breaking Capacity	
switching capacity current	
• according to EN 60898-1 rated value	6 000 A
• according to IEC 60947-2 rated value	6 000 A
energy limitation class	3
Dissipation	
power loss [W] for rated value of the current at AC in hot operating state per pole	1.35 W
Product details	
product feature halogen-free	Yes
product feature silicon-free	Yes
product extension installable supplementary devices	Yes
Connections	
connectable conductor cross-section solid	
• minimum	0.75 mm ²
• maximum	16 mm ²

connectable conductor cross-section stranded	
• minimum	0.75 mm ²
• maximum	16 mm ²
connectable conductor cross-section finely stranded with core end processing	
• minimum	0.75 mm ²
• maximum	10 mm ²
tightening torque with screw-type terminals	
• minimum	1.2 N·m
• maximum	2 N·m
position of power supply cord	any

Mechanical Design

height	90 mm
width	18 mm
depth	68.5 mm
installation depth	70 mm
number of modular width units	1
fastening method	DIN rail
mounting position	any
Net Weight	120 g

Environmental conditions

ambient temperature during operation	
• minimum	-25 °C
• maximum	45 °C
ambient temperature during storage	
• minimum	-40 °C
• maximum	75 °C
ambient temperature with relative humidity 95%	55 °C
number of test cycles for environmental testing according to IEC 60068-2-30	28

Certificates

reference code according to IEC 81346-2	F
--	---

Approvals Certificates

General Product Approval	other	Environment
---------------------------------	-------	-------------



[Confirmation](#)



[Environmental Confirmations](#)

[Environmental Confirmations](#)

Further information

Information on the packaging

<https://support.industry.siemens.com/cs/ww/en/view/109813875>

Information for data generation and storage

<https://support.industry.siemens.com/cs/ww/en/view/109995012>

Information- and Downloadcenter (Catalogs, Brochures,...)

<https://www.siemens.com/lowvoltage/catalogs>

Industry Mall (Online ordering system)

<https://mall.industry.siemens.com/mall/en/en/Catalog/product?mlfb=5SV6016-6GV16>

Service&Support (Manuals, Certificates, Characteristics, FAQs,...)

<https://support.industry.siemens.com/cs/ww/en/ps/5SV6016-6GV16>

Image database (product images, 2D dimension drawings, 3D models, device circuit diagrams, ...)

https://www.automation.siemens.com/bilddb/cax_en.aspx?mlfb=5SV6016-6GV16

CAx-Online-Generator

<https://www.siemens.com/cax>

Tender specifications

<https://www.siemens.com/specifications>

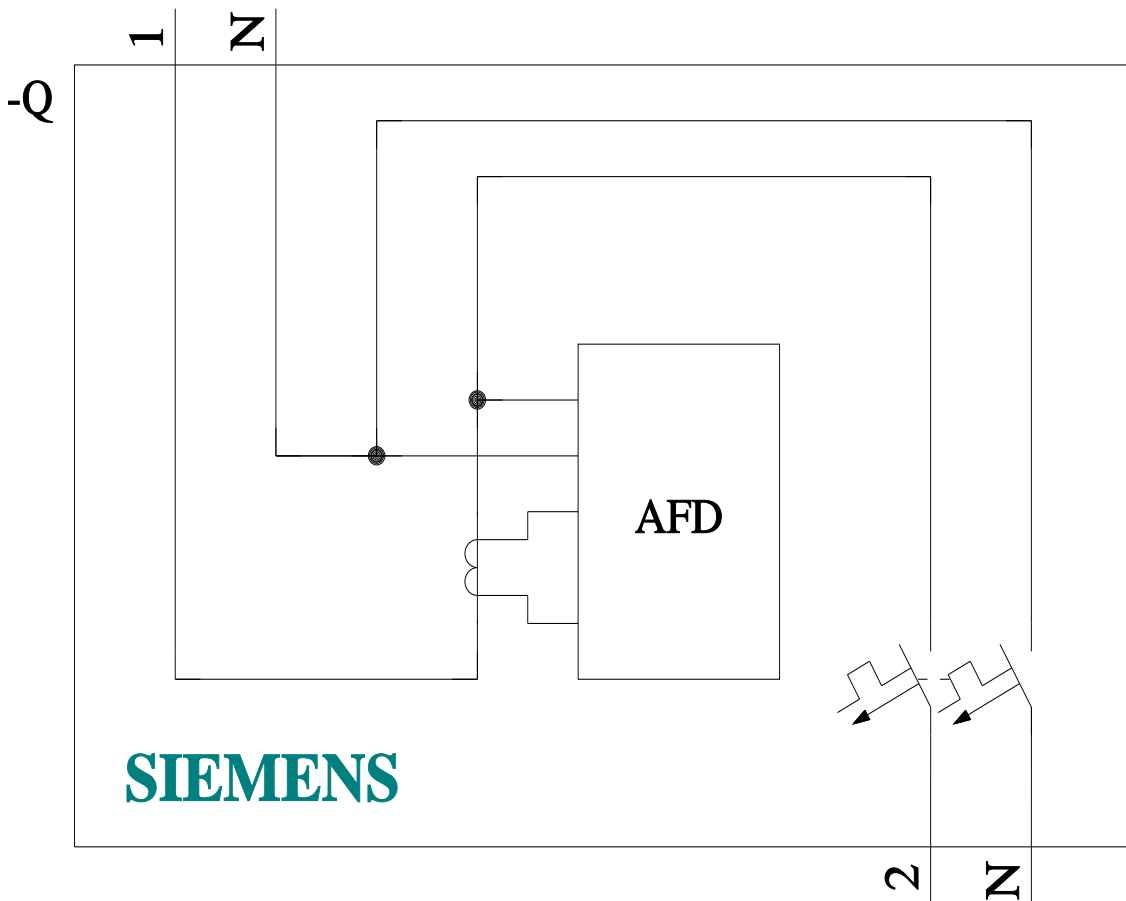
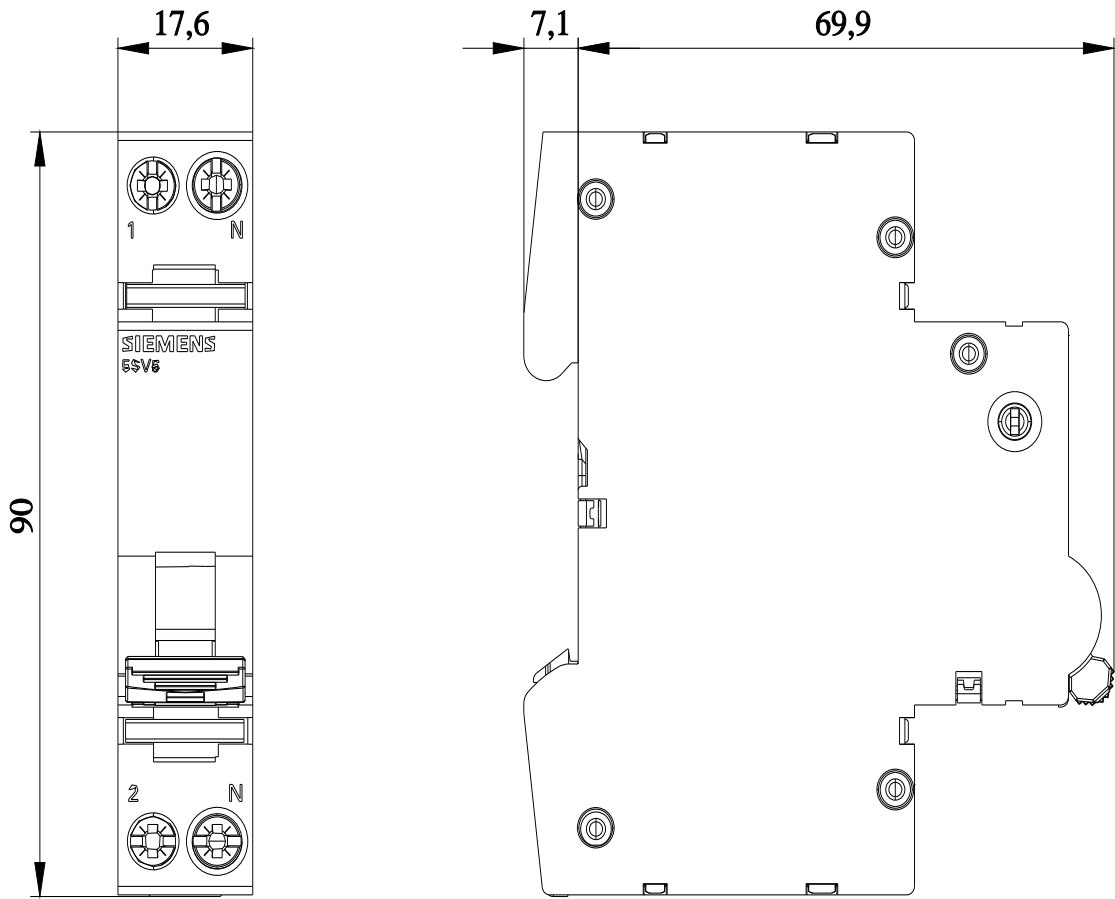

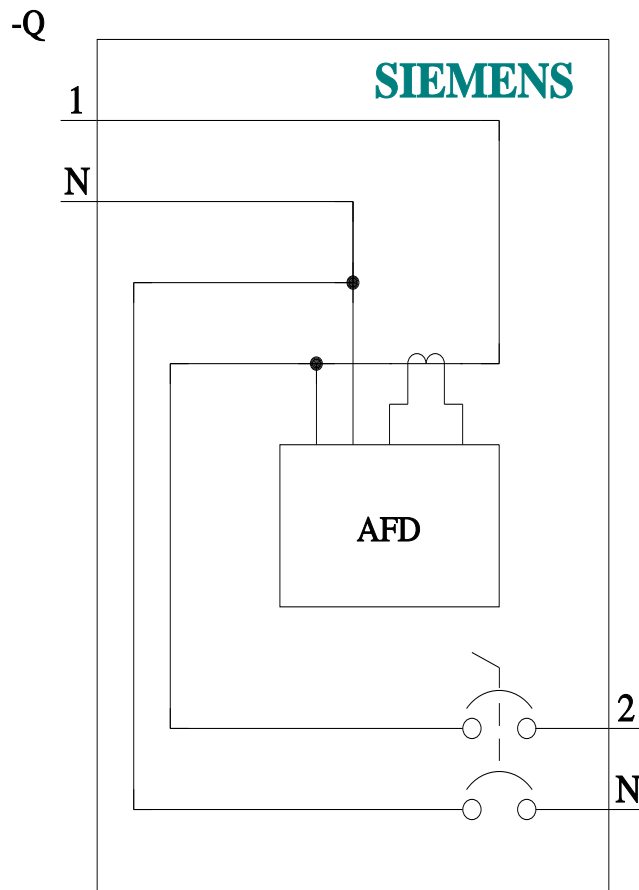

last modified:

7/19/2025 

